

TEM®

2022
Fiyat Listesi

İÇİNDEKİLER

2-3 ● Monofoze Fiş & Prizler

4 ● Trifaze Fiş & Prizler

5-7 ● Modüler Prizler

8 ● IEC Soketler

9 ● GST Soketler

10 ● Gerilim Koruma (SPD)

11-12 ● Şarj Cihazları

13-14 ● Faceplate - Konnektörler - Kapaklar

15-16 ● Multimedya Soketler

17 ● Akım Koruma Cihazları - Anahtarlar

18 ● Bluetooth Hoparlör

19-27 ● Alüminyum Grup Prizler

28-32 ● Masa Tipi Grup Prizler

33-37 ● Aydınlatma Grubu

38-39 ● Priz Kutuları

40-50 ● CEE Norm Fiş & Prizler

51-55 ● Kombinasyon Kutuları

56 ● Taşıyıcı Ayak

57 ● Termoplastik Buatlar

58-63 ● Plastik Panolar

64-67 ● Kablo Makaraları

68-72 ● İzolatörler

● Baladoz

● Bant Armatür Soketleri

● Kablolar

● Kablo Bağı





Monofaze Prizler

16A

2P+E

200-250 V~

Tek Terminal IP44

Çift Terminal IP54



214.311.112.001
Şebeke Pano Prizi
39,00 TL



214.321.112.001
UPS Pano Prizi
44,00 TL



215.311.212.001
Şebeke Pano Prizi
41,00 TL



215.321.212.001
UPS Pano Prizi
46,00 TL



215.351.212.101
Fransız Pano Prizi
43,00 TL



440.116.160
IP44
Eğik Makine Prizi
54,00 TL



670.116.160
IP67 Kilitli Kapaklı
Eğik Makine Prizi
75,00 TL



440.116.150
IP44
Makine Prizi
54,00 TL



440.116.151
IP44 Dik Kasalı
Duvar Prizi
77,00 TL



440.116.152
IP44 Eğik Kasalı
Duvar Prizi
84,00 TL



440.116.153
IP44 Eğik Kasalı Duvar Prizi
+ Monofaze Pano Prizi
120,00 TL



Monofaze Kauçuk Fiş & Prizler

16A

2P+E

200-250 V~



215.116.200
Seyyar Priz
46,00 TL



215.116.301
Düz Uzun Fiş
35,00 TL



215.116.300 | 215.316.300
Şebeke Düz Fiş | UPS Düz Fiş
34,00 TL | 35,00 TL



215.116.320 | 215.316.320
Şebeke Eğik Fiş | UPS Eğik Fiş
37,00 TL | 38,00 TL



215.116.101
Tekli Priz
55,00 TL



215.116.102
İkili Grup Priz
104,00 TL



215.116.103
Üçlü Grup Priz
115,00 TL



215.116.104
Dörtlü Grup Priz
150,00 TL





TEM RAY PRİZLERİ

Standart Sigorta Rayına Uygun Prizler



Ray Tipi Monofaze Prizler

2P+E

200-250 V~



272.313.110.011
Ray Tipi
Şebeke Prizi
Ledli
90,00 TL

272.313.110.001
Ray Tipi
Şebeke Prizi
Ledsiz
80,00 TL



272.323.110.011
Ray Tipi
UPS Prizi
Ledli
106,00 TL

272.323.110.001
Ray Tipi
UPS Prizi
Ledsiz
96,00 TL



272.353.110.111
Ray Tipi
Fransız Prizi
Ledli
100,00 TL

272.353.110.101
Ray Tipi
Fransız Prizi
Ledsiz
90,00 TL

Trifaze Fiş & Prizler 4x25 A

25A

380-415 V~



540.425.300 
Fiş
50,00 TL



540.425.200 
Seyyar Priz
75,00 TL



540.425.110 
Duvar Prizi Klemensli
85,00 TL



540.425.111 
1 Ad. Trifaze + 1 Ad. Monofaze
Grup Priz
165,00 TL



540.425.121 
2 Ad. Trifaze + 1 Ad. Monofaze
Grup Priz
250,00 TL



540.425.112 
1 Ad. Trifaze + 2 Ad. Monofaze
Grup Priz
240,00 TL



540.425.130 
3 Ad. Trifaze
Grup Priz
260,00 TL



540.425.150 
Pano Prizi
65,00 TL



540.425.151 
Dik Kasalı Duvar Prizi
92,00 TL



540.425.152 
Eğik Kasalı Duvar Prizi
105,00 TL



540.425.153 
Eğik Kasalı Duvar Prizi
+ Monofaze Pano Prizi
175,00 TL

Kauçuk Trifaze Prizler 3x16 A

16A

IP44

380-415 V~



544.316.300 
Fiş
95,00 TL



544.316.150 
Pano Prizi
77,00 TL



544.316.151 
Dik Kasalı Duvar Prizi
98,00 TL



544.316.152 
Eğik Kasalı Duvar Prizi
110,00 TL



544.316.153 
Eğik Kasalı Duvar Prizi
+ Monofaze Pano Prizi
180,00 TL

Kauçuk Trifaze Prizler 3x32 A

32A

IP44

380-415 V~



544.332.300 
Fiş
130,00 TL



544.332.150 
Pano Prizi
97,00 TL



544.332.151 
Dik Kasalı Duvar Prizi
112,00 TL



544.332.152 
Eğik Kasalı Duvar Prizi
128,00 TL



544.332.153 
Eğik Kasalı Duvar Prizi
+ Monofaze Pano Prizi
205,00 TL



252.310.120.001
Vidalı Şebeke Prizi 45°
30,00 TL



252.320.120.001
Vidalı UPS Prizi 45°
34,00 TL



252.311.110.001
Tırnaklı Tek Klemensli Şebeke Prizi
30,00 TL



252.321.110.001
Tırnaklı Tek Klemensli UPS Prizi
34,00 TL



252.311.120.001
Tırnaklı Tek Klemensli
Şebeke Prizi 45°
30,00 TL



252.321.120.001
Tırnaklı Tek Klemensli
UPS Prizi 45°
34,00 TL



252.311.210.001
Tırnaklı Çift Klemensli
Şebeke Prizi
32,00 TL



252.321.210.001
Tırnaklı Çift Klemensli
UPS Prizi
36,00 TL



252.311.220.001
Tırnaklı Çift Klemensli
Şebeke Prizi 45°
32,00 TL



252.321.220.001
Tırnaklı Çift Klemensli
UPS Prizi 45°
36,00 TL



252.351.110.001
Tırnaklı Tek Klemensli
Fransız Prizi 45°
36,00 TL



252.351.120.001
Tırnaklı Tek Klemensli
Fransız Prizi
36,00 TL

Kapaklı Prizler



Çift tırnak sayesinde dikey ve yatay kullanımlara uygundur.



252.312.210.001
Çift Tırnaklı Çift Klemensli
Kapaklı Şebeke Prizi
40,00 TL



252.322.210.001
Çift Tırnaklı Çift Klemensli
Kapaklı UPS Prizi
45,50 TL



252.312.220.101
Çift Tırnaklı Çift Klemensli
Şebeke Prizi 45°
37,50 TL



740.061.002
Priz Birleştirme
Aparatı
17,00 TL



252.322.220.101
Çift Tırnaklı Çift Klemensli
UPS Prizi 45°
43,00 TL



253.611.101
45x45mm Universal Priz
75,00 TL



253.711.101
45x45mm Amerikan Prizi
65,00 TL



253.811.101
45x45mm İngiliz Prizi
56,50 TL



253.411.101
51x45mm İngiliz Prizi
58,50 TL



721.130.300
İngiliz Fişi
70,00 TL



ŞEBEKE TİP

16A 2P+E 200-250 V~



	Açıklama	Ürün Kodu	B.Fiyat	Çocuk Emniyetli Kod	B.Fiyat
Kablolu	2'li Şebeke Prizi	262.31.132.002	60,00 TL	262.31.132.012	68,00 TL
	3'lü Şebeke Prizi	262.31.132.003	87,00 TL	262.31.132.013	99,00 TL
	4'lü Şebeke Prizi	262.31.132.004	112,00 TL	262.31.132.014	128,00 TL
Klemensli	2'li Şebeke Prizi	262.31.112.002	74,00 TL	262.31.112.012	82,00 TL
	3'lü Şebeke Prizi	262.31.112.003	96,00 TL	262.31.112.013	108,00 TL
	4'lü Şebeke Prizi	262.31.112.004	123,00 TL	262.31.112.014	139,00 TL
Çift Klemensli	2'li Şebeke Prizi	262.31.122.002	106,00 TL	262.31.122.012	114,00 TL
	3'lü Şebeke Prizi	262.31.122.003	124,00 TL	262.31.122.013	136,00 TL
	4'lü Şebeke Prizi	262.31.122.004	155,00 TL	262.31.122.014	171,00 TL

UPS TİP

16A 2P+E 200-250 V~



	Açıklama	Ürün Kodu	B.Fiyat	Çocuk Emniyetli Kod	B.Fiyat
Kablolu	2'li UPS Prizi	262.32.132.002	70,00 TL	262.32.132.012	78,00 TL
	3'lü UPS Prizi	262.32.132.003	100,00 TL	262.32.132.013	112,00 TL
	4'lü UPS Prizi	262.32.132.004	130,00 TL	262.32.132.014	146,00 TL
Klemensli	2'li UPS Prizi	262.32.112.002	80,00 TL	262.32.112.012	88,00 TL
	3'lü UPS Prizi	262.32.112.003	102,00 TL	262.32.112.013	114,00 TL
	4'lü UPS Prizi	262.32.112.004	130,00 TL	262.32.112.014	146,00 TL
Çift Klemensli	2'li UPS Prizi	262.32.122.002	115,00 TL	262.32.122.012	123,00 TL
	3'lü UPS Prizi	262.32.122.003	136,00 TL	262.32.122.013	148,00 TL
	4'lü UPS Prizi	262.32.122.004	169,00 TL	262.32.122.014	185,00 TL

FRANSIZ TİP

16A 2P+E 200-250 V~



	Açıklama	Ürün Kodu	B.Fiyat
Kablolu	2'li Fransız Prizi	262.35.132.002	78,00 TL
	3'lü Fransız Prizi	262.35.132.003	112,00 TL
	4'lü Fransız Prizi	262.35.132.004	145,00 TL
Klemensli	2'li Fransız Prizi	262.35.112.002	98,00 TL
	3'lü Fransız Prizi	262.35.112.003	125,00 TL
	4'lü Fransız Prizi	262.35.112.004	160,00 TL
Çift Klemensli	2'li Fransız Prizi	262.35.122.002	130,00 TL
	3'lü Fransız Prizi	262.35.122.003	160,00 TL
	4'lü Fransız Prizi	262.35.122.004	195,00 TL

BİLGİSAYAR IEC TİP 10A 2P+E 200-250 V~



Açıklama	Ürün Kodu	B.Fiyat
2'li Bilgisayar Prizi	262.33.131.002	70,00 TL
3'lü Bilgisayar Prizi	262.33.131.003	85,00 TL
4'lü Bilgisayar Prizi	262.33.131.004	108,00 TL

İNGİLİZ TİP

13A 2P+E 200-250 V~

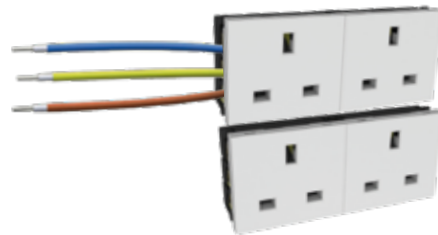

	Açıklama	Ürün Kodu	B.Fiyat
Kablolu	2'li İngiliz Prizi	262.38.131.002	90,00 TL
	3'lü İngiliz Prizi	262.38.131.003	105,00 TL
	4'lü İngiliz Prizi	262.38.131.004	140,00 TL
Çift Klemensli	2'li İngiliz Prizi	262.38.121.002	130,00 TL
	3'lü İngiliz Prizi	262.38.121.003	160,00 TL
	4'lü İngiliz Prizi	262.38.121.004	195,00 TL



720.130.150
IEC C13 10A
Tırnaklı Gövde Priz
16,00 TL



720.130.160
IEC C13 10A
Vidalı Gövde Priz
16,00 TL



720.130.200
IEC C13 10A
Seyyar Priz
27,00 TL



720.140.320
IEC C14 10A
Tırnaklı Gövde Fiş
16,00 TL



720.140.340
IEC C14 10A
Vidalı Gövde Fiş
16,00 TL



720.140.300
IEC C14 10A
Seyyar Fiş
27,00 TL



720.140.321
IEC C14 10A
Gövdede Fiş
18,00 TL



720.190.150
IEC C19 16A
Tırnaklı Gövde Priz
47,00 TL



720.190.160
IEC C19 16A
Vidalı Gövde Priz
47,00 TL



720.190.200
IEC C19 16A
Seyyar Priz
148,00 TL



720.200.320
IEC C20 16A
Tırnaklı Gövde Fiş
56,00 TL



720.240.340
IEC C20 16A
Vidalı Gövde Fiş
56,00 TL



720.200.300
IEC C20 16A
Seyyar Fiş
148,00 TL



720.200.321
IEC C20 16A
Gövdede Fiş
76,50 TL



724.021.000
Seyyar Gst Soket
Dişi
41,00 TL



724.011.000
Seyyar Gst Soket
Erkek
38,00 TL



724.020.000
GST Soket Dişi
28,00 TL



724.010.000
GST Soket Erkek
26,00 TL

724.000.010
Plastik Kilit



2.5mm² Soket Klemensler



720.400.200 - Beyaz
720.400.201 - Siyah
720.400.202 - Kırmızı
Erkek - Dişi Takım Soketler
48,00 TL



720.500.002 2'li
Klemens
9,00 TL



720.500.003 3'lü
Klemens
11,70 TL



720.500.004 4'lü
Klemens
14,50 TL



720.500.005 5'li
Klemens
18,00 TL

tem SPD 0120 TİP 3 Gerilim Koruma

U_c : 255V - 50-60 Hz

U_{oc} : 5/10 kV

I_n : 2,5/5 kA

U_p : $\leq 1,5$ kV



22.5x45mm

734.612.0120.X

SPD 0120

230,00 TL



45x45mm

734.613.0120.X

SPD 0120

250,00 TL

Not: Ürünün üzerindeki gösterge ışığı
Yeşil yanıyor ise, ürünün normal çalıştığı,
Kırmızı yanıyor ise, ürünün değiştirilmesi gerektiği anlaşılmalıdır.

X = 0 Beyaz

X = 1 Siyah

tem SPD 1119 TİP 3 Gerilim Koruma

U_c : 255V - 50-60 Hz

U_{oc} : 5 kV

I_n : 3 kA

U_p : ≤ 2 kV



45x45mm

734.613.1119.X

SPD 1119

260,00 TL

tem SPD 1119-N TİP 3 Gerilim Koruma Filtreli

U_c : 255V - 50-60 Hz

U_{oc} : 5 kV

I_n : 3 kA

U_p : ≤ 2 kV

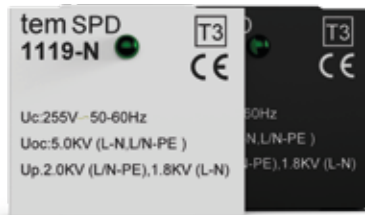

45x45mm

734.613.1119.XN

SPD 1119-N

285,00 TL

Not: Ürünün üzerindeki gösterge ışığı
Yeşil yanarsa, ürünün normal çalıştığı,
yanmıyorsa ürünün değiştirilmesi gerektiği anlaşılmalıdır.

X = 0 Beyaz

X = 1 Siyah



TEM Kablosuz Şarj



Ürün Kodu

715.200.13X

Fiyat

250,00 TL

Giriş

5V-2A 9V-2A

Çıkış

5-7,5W

İletim Mesafesi

≤ 8mm
(Önerilen: 2mm / 4mm)

Verimlilik

≥ 73%

Standart

Qi

Kablosuz şarj cihazı, minimal tasarımıdır, Qi standartlarına sahiptir. Kablosuz şarj özelliği olan cep telefonlarıyla uyumlu akıllı bir üründür. Cep telefonu şarj olurken kablo bağlantısı yapılmaz, bu daha rahat ve verimlidir. Kablosuz şarj işleviyle size özgürlük, güvenlik ve konfor sağlar.

Şık ve fonksiyonel tasarım

Kaymaz yüzeyi ile telefonunuzu güvende tutar.

3mm kalınlığa kadar kasa veyahut kılıfla uyumludur.

Aşırı Sıcaklık ve akım koruması

Cihazlarınız için 7,5W'a kadar hızlı kablosuz şarjı destekler.

Yabancı Nesne Algılama (FOOD) özelliği

Renk

X = 1 Siyah



X = 2 Gri





715.200.12X
TİP A/C - 30W(max)
45x45mm (Siyah - Beyaz)
590,00 TL

X = 0 Beyaz

X = 1 Siyah

22.5x45mm USB Şarj Cihazları



715.200.20X
TİP A - 2.1A
22.5x45mm (Siyah - Beyaz)
200,00 TL



715.200.21X
TİP A/C - 2.1A
22.5x45mm (Siyah - Beyaz)
250,00 TL



715.200.11X
TİP A - 2 A
22.5x45mm (Siyah - Beyaz)
300,00 TL



715.200.10X
TİP A - 1 A
22.5x45mm (Siyah - Beyaz)
250,00 TL

X = 0 Beyaz

X = 1 Siyah

45x45mm USB Şarj Cihazları



715.100.10X
TİP A/C - 2.1 A
45x45mm (Siyah - Beyaz)
330,00 TL



715.100.11X
TİP A/A - 2.1 A
45x45mm (Siyah - Beyaz)
290,00 TL

X = 0 Beyaz

X = 1 Siyah



710.100.103
45x45mm Yaylı Kapaklı
0,78 USD

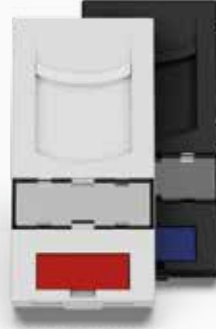

710.100.104
22x45mm Yaylı Kapaklı
0,65 USD



710.100.105
45x45mm Yaylı Kapaklı - Çiftli
1,30 USD



Telefon -Data Konnektörleri

Dişi - Dişi Telefon - Data Konnektörleri



715.100.030
CAT3 TELEFON
1,00 USD



715.100.050
CAT5E DATA
1,50 USD



715.100.060
CAT6 DATA
1,80 USD



715.100.061
CAT6A DATA
5,80 USD



715.200.030
CAT3 TELEFON
3,30 USD



715.200.050
CAT5E DATA
3,60 USD



715.200.060
CAT6 DATA
3,60 USD

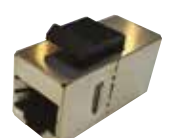

715.200.061
CAT6A DATA
5,80 USD



Telefon Data Fişleri



710.100.350
CAT5 DATA Fişi
0,10 USD



710.100.360
CAT6 DATA Fişi
0,20 USD



710.100.332 - 2 PIN
710.100.334 - 4 PIN
710.100.336 - 6PIN
TELEFON Fişi
0,08 USD





708.100.010
50x50mm - Tekli
6,00TL



708.100.020
50x50mm - Çiftli
6,00TL



709.100.103
45x45mm
6,75TL



709.100.104
22.5x45mm
6,00TL



Kanal Üstü Telefon - Data Kapakları



710.100.107
45x45mm Kapaksız - Çiftli
20,50 TL



710.100.111
22.5x45mm Kapaksız - Tekli
20,50 TL



710.100.106
45x45mm Kapaksız- Tekli
18,00 TL



709.200.104
22x45mm
6,00TL



709.200.103
45x45mm
6,75TL



45x45mm Kanal Üstü Keystone Kapakları



710.100.108
Yükseltme Kapağı
9,50TL



710.100.109
Keystone - Faceplate - Tekli
17,00 TL



710.100.110
Keystone - Faceplate - Çiftli
18,50 TL

Fiberoptik Keystone



715.800.001
Fiber optik Keystone
90,00 TL



715.800.002
Fiber optik Keystone
90,00 TL



715.800.003
Fiber optik Keystone
90,00 TL



45x45mm Tv Prizler



723.000.150
TV Prizi
56,00 TL



723.000.300
TV Prizi Erkek Ø9.52mm
56,00 TL



723.000.400
TV Uydu Prizi
61,00 TL

VGA Konnektörleri



715.300.001
6+2 Klemens Girişli
22.5x45mm - Faceplate
100,00 TL



715.300.002
14+2 Klemens Girişli 22.5x45mm
Hızlı Montaj - Faceplate
120,00 TL



715.300.003
Soket Girişli
45x45mm - Faceplate
90,00 TL



715.300.004
Soket Girişli
22.5x45mm - Faceplate
60,00 TL



715.300.005
15 Klemens Girişli
22.5x45mm - Faceplate
100,00 TL



715.300.007
9 Pinli
22.5x45mm Faceplate
100,00 TL



715.300.009
B Soket Girişli
45x45mm - Faceplate
120,00 TL

RCA & STEREO Konnektörleri



715.500.002
RCA Konnektör 22.5x45mm
Klemensli - Faceplate
70,00 TL



715.500.001
RCA Konnektör 22.5x45mm
Klemensli - Faceplate
70,00 TL



715.600.001
Stereo Konnektör 22.5x45mm
Klemensli - Faceplate
40,00 TL

HDMI Konnektörleri



715.400.001
TİP A Dişi - Dişi 90°
22.5x45mm - Faceplate
100,00 TL



715.400.002
TİP A Dişi - Dişi 180°
22.5x45mm - Faceplate
100,00 TL



715.400.003
TİP A Dişi - Dişi Üstten
Giriş-Çıkışlı
22.5x45mm - Faceplate
100,00 TL

HDMI Konnektör



715.400.008
HDMI Konnektör TİP A Dişi-Dişi
45x45mm - Faceplate
200,00 TL

DISPLAY Konnektör



715.700.001
Display Port Konnektör Soket Girişli
45x45mm - Faceplate
200,00 TL

XLR Konnektör



715.600.002
XLR Dişi Soket
45x45mm Klemensli - Faceplate
100,00 TL

USB Konnektörleri



715.200.004
Standart A
USB AF/AF 90°
22.5x45mm - Faceplate
40,00 TL



715.200.005
Standart A
USB AF/AF 180°
22.5x45mm - Faceplate
40,00 TL



715.200.006
Standart A
Klemensli
22.5x45mm - Faceplate
40,00 TL

USB / HDMI Keystone



715.200.001
Standart B
Dişi - Dişi - Keystone
50,00 TL



715.200.002
Standart A
Dişi - Dişi - Keystone
50,00 TL



715.200.003
Standart A
Dişi - Dişi Kablolu - Keystone
135,00 TL



715.400.004
TİP A Dişi - Dişi
Keystone
70,00 TL



715.400.005
TİP A Dişi - Dişi
Kablolu Keystone
180,00 TL

tem Akım Koruma

Akım Deęeri : 16A
Voltaj Deęeri : 125/250 V AC
Yalıtım Direnci : >100MOHM (DC 500V)
Koruma Derecesi : IP40



723.225.016
Butonlu Akım Koruma
22.5x45mm
33,00 TL



723.225.116
Anahtarlı Akım
Koruma 22.5x45mm
33,00 TL

On - Off Anahtarlar



722.045.012
Tekli Anahtar 16A
45x45mm
Işıksız
35,00 TL

722.045.112
Tekli Anahtar 16A
45x45mm
Işıklı
37,00 TL



722.045.011
Çiftli Anahtar
2x10A 45x45mm
Işıksız
52,00 TL

722.045.111
Çiftli Anahtar
2x10A 45x45mm
Işıklı
54,00 TL



722.225.010
Anahtar 10A
22.5x45mm
Işıksız
28,00 TL

722.225.110
Anahtar 10A
22.5x45mm
Işıklı
30,00 TL



722.225.021
Anahtar 16A
22.5x45mm
Işıksız
35,00 TL



722.045.022
Çift Anahtar 2x16A
45x45mm
Işıksız
50,00 TL



722.225.112
Anahtar 16A
22.5x45mm
Işıklı
40,00 TL



722.045.122
Çift Anahtar 2x16A
45x45mm
Işıklı
60,00 TL



Bluetooth 5.0

Android - IOS Uyumlu

Sinyal Gürültü Oranı : 95DB

Çalışma Sıcaklığı : 10 - 40 °C

Çalışma Nemi : 35 ~ 85%

İletişim Uzaklığı : 10m

Frekans Tepkisi : 120Hz - 18KHz



TEM Bluetooth Hoparlör

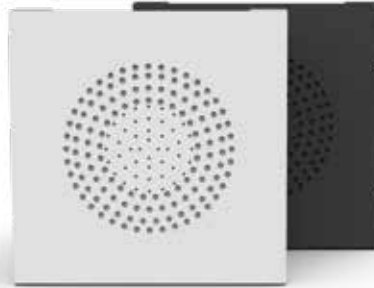

715.200.12X

240V AC / 50-60Hz 0.3A
45x45mm (Siyah - Beyaz)

596,00 TL

X = 3 Beyaz

X = 4 Siyah

Örnek Ürünler



1620.1200.11101

2 Şebeke + 2'li USB Şarj
+ Bluetooth Hoparlör + 45cm Profil
1.750,00 TL



1620.1200.1182101

2 Şebeke + 2 Cat6 + 2'li USB Şarj
+ Bluetooth Hoparlör + 50cm Profil
1.970,00 TL



1620.1300.11101

3 Şebeke + 2'li USB Şarj
+ Bluetooth Hoparlör + 55cm Profil
1.840,00 TL

TEM 1U PDU

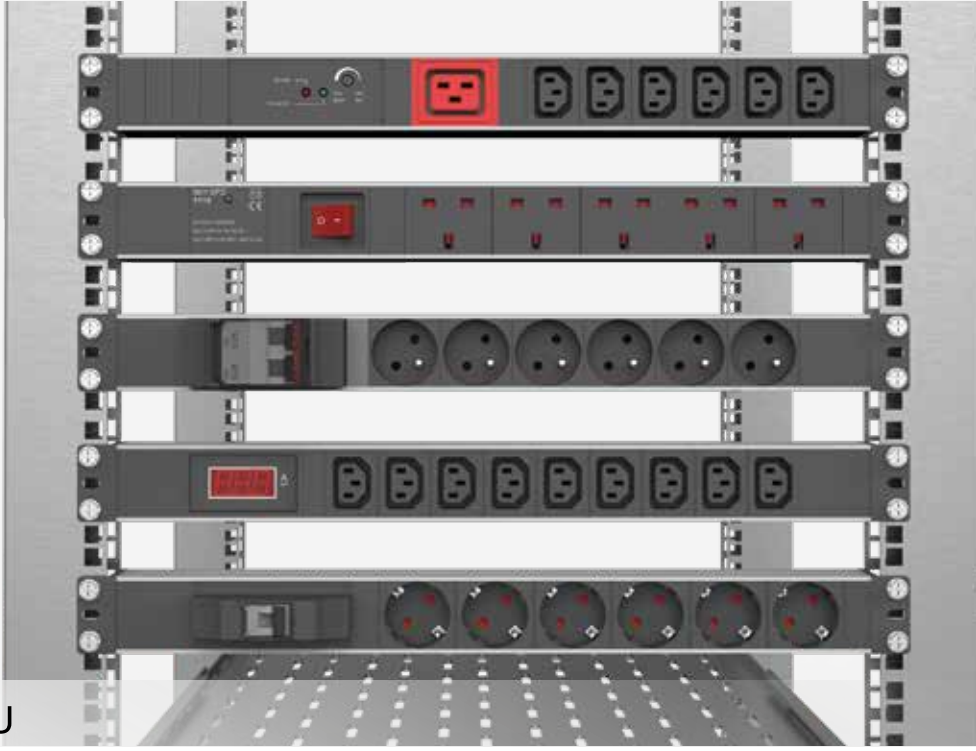

Standart



Ürün Kodu

- 14000.1070.000
- 14000.1080.000
- 19 14000.1090.000
- 14000.2070.000
- 14000.2080.000
- 19 14000.2090.000

Açıklama

- 7 Şebeke
- 8 Şebeke
- 9 Şebeke
- 7 UPS
- 8 UPS
- 9 UPS

Fiyat

- 295,00 TL
- 330,00 TL
- 365,00 TL
- 325,00 TL
- 360,00 TL
- 400,00 TL

Gerilim Korumalı



Ürün Kodu

- 14004.1060.000
- 19 14004.1070.000
- 14004.1080.000
- 14004.2060.000
- 19 14004.2070.000
- 14004.2080.000

Açıklama

- 6 Şebeke + Gerilim Koruma
- 7 Şebeke + Gerilim Koruma
- 8 Şebeke + Gerilim Koruma
- 6 UPS + Gerilim Koruma
- 7 UPS + Gerilim Koruma
- 8 UPS + Gerilim Koruma

Fiyat

- 495,00 TL
- 540,00 TL
- 570,00 TL
- 530,00 TL
- 565,00 TL
- 610,00 TL

Anahtarlı



Ürün Kodu

- 14003.1060.000
- 14003.1070.000
- 19 14003.1080.000
- 14003.2060.000
- 14003.2070.000
- 19 14003.2080.000

Açıklama

- 6 Şebeke + Anahtar
- 7 Şebeke + Anahtar
- 8 Şebeke + Anahtar
- 6 UPS + Anahtar
- 7 UPS + Anahtar
- 8 UPS + Anahtar

Fiyat

- 306,00 TL
- 341,00 TL
- 376,00 TL
- 330,00 TL
- 370,00 TL
- 408,00 TL

Tek Sigortalı



Ürün Kodu

- 14001.1040.000
- 19 14001.1060.000
- 14001.1080.000
- 14001.2040.000
- 19 14001.2060.000
- 14001.2080.000

Açıklama

- 4 Şebeke + Tekli Sigorta
- 6 Şebeke + Tekli Sigorta
- 8 Şebeke + Tekli Sigorta
- 4 UPS + Tekli Sigorta
- 6 UPS + Tekli Sigorta
- 8 UPS + Tekli Sigorta

Fiyat

- 335,00 TL
- 390,00 TL
- 460,00 TL
- 350,00 TL
- 410,00 TL
- 490,00 TL

Çift Sigortalı



Ürün Kodu

- 14002.1040.000
- 19 14002.1060.000
- 14002.1080.000
- 14002.2040.000
- 19 14002.2060.000
- 14002.2080.000

Açıklama

- 4 Şebeke + Çift Sigortalı
- 6 Şebeke + Çift Sigortalı
- 8 Şebeke + Çift Sigortalı
- 4 UPS + Çift Sigortalı
- 6 UPS + Çift Sigortalı
- 8 UPS + Çift Sigortalı

Fiyat

- 531,00 TL
- 586,00 TL
- 656,00 TL
- 548,00 TL
- 610,00 TL
- 690,00 TL

Butonlu Akım Korumalı



Ürün Kodu

- 14012.1060.000
- 14012.1070.000
- 19 14012.1080.000
- 14012.2060.000
- 14012.2070.000
- 19 14012.2080.000

Açıklama

- 6 Şebeke + Akım Koruma
- 7 Şebeke + Akım Koruma
- 8 Şebeke + Akım Koruma
- 6 UPS + Akım Koruma
- 7 UPS + Akım Koruma
- 8 UPS + Akım Koruma

Fiyat

- 340,00 TL
- 375,00 TL
- 410,00 TL
- 363,00 TL
- 404,00 TL
- 441,00 TL

Anahtarlı Akım Korumalı



Ürün Kodu

- 14013.1060.000
- 14013.1070.000
- 19 14013.1080.000
- 14013.2060.000
- 14013.2070.000
- 19 14013.2080.000

Açıklama

- 6 Şebeke + Anahtarlı Akım Koruma
- 7 Şebeke + Anahtarlı Akım Koruma
- 8 Şebeke + Anahtarlı Akım Koruma
- 6 UPS + Anahtarlı Akım Koruma
- 7 UPS + Anahtarlı Akım Koruma
- 8 UPS + Anahtarlı Akım Koruma

Fiyat

- 346,00 TL
- 382,00 TL
- 416,00 TL
- 370,00 TL
- 410,00 TL
- 448,00 TL

1U Kapak Modelleri



TEM 1U GST PDU



14002.0000.003
Çift Sigorta Modülü
495,00 TL



14014.0000.003
SPD + EMI-RFI Filtre Modülü
985,00 TL



14015.0000.003
SPD + Anahtar Modülü
425,00 TL



14000.1020.0202.3
2'li USB Şarj + 2 Şebeke
572,00 TL



14000.1040.003
4 Şebeke
315,00 TL



14003.1030.003
3 Şebeke + Anahtar
321,00 TL



725.3150.893
GST (Dişi + Erkek)
3x1,5 H05VV-F 3m
230,00 TL



725.3150.913
3m GST Dişi + Unischuko
3x1,5 H05VV-F 3m
185,00 TL



725.3150.933
3m GST Dişi + C14
3x1,5 H05VV-F 3m
265,00 TL



TEM U62 PDU

Boş Alüminyum Gövde



Ürün Kodu

Modül Sayısı (22,5mm)

Fiyat

16200.0010.000	8 + 2 x 22.5	210,00 TL
16200.0012.000	10 + 2 x 22.5	240,00 TL
16200.0014.000	12 + 2 x 22.5	270,00 TL
16200.0016.000	14 + 2 x 22.5	300,00 TL
16200.0018.000	16 + 2 x 22.5	335,00 TL
16200.0020.000	18 + 2 x 22.5	365,00 TL

Örnek Ürünler



16200.1232.8711.0
3 Şebeke + 2 UPS + 1 Cat6 + 1 Cat3
675,00 TL



16200.1222.8722.0
2 Şebeke + 2 UPS + 2 Cat6 + 2 Cat3
790,00 TL



16200.1222.872111.0
2 Şebeke + 2 UPS + 1 Cat6 + 1 Cat 3
+ 2'li USB Şarj
965,00 TL



16200.1223.8721.0
2 Şebeke + 3 UPS + 2 Cat6 + 1 Cat3
780,00 TL



16200.1233.8711.0
3 Şebeke + 3 UPS + 1 Cat6 + 1 Cat3
740,00 TL



16200.1030.153111.0
3 Şebeke + 1 VGA + 1 HDMI + 1 USB Şarj
975,00 TL



TEM U42 PDU

Standart



Ürün Kodu

- 14200.1070.000
- 19 14200.1080.000
- 14200.1090.000
- 14200.2070.000
- 19 14200.2080.000
- 14200.2090.000

Açıklama

- 7 Şebeke
- 8 Şebeke
- 9 Şebeke
- 7 UPS
- 8 UPS
- 9 UPS

Fiyat

- 610,00 TL
- 660,00 TL
- 710,00 TL
- 640,00 TL
- 700,00 TL
- 760,00 TL

Tek Sigortalı



Ürün Kodu

- 14201.1040.000
- 19 14201.1060.000
- 14201.1080.000
- 14201.2040.000
- 19 14201.2060.000
- 14201.2080.000

Açıklama

- 4 Şebeke + Tekli Sigorta
- 6 Şebeke + Tekli Sigorta
- 8 Şebeke + Tekli Sigorta
- 4 UPS + Tekli Sigorta
- 6 UPS + Tekli Sigorta
- 8 UPS + Tekli Sigorta

Fiyat

- 580,00 TL
- 690,00 TL
- 800,00 TL
- 600,00 TL
- 720,00 TL
- 840,00 TL

Anahtarlı



Ürün Kodu

- 14203.1060.000
- 19 14203.1070.000
- 14203.1080.000
- 14203.2060.000
- 19 14203.2070.000
- 14203.2080.000

Açıklama

- 6 Şebeke + Anahtar
- 7 Şebeke + Anahtar
- 8 Şebeke + Anahtar
- 6 UPS + Anahtar
- 7 UPS + Anahtar
- 8 UPS + Anahtar

Fiyat

- 540,00 TL
- 600,00 TL
- 660,00 TL
- 570,00 TL
- 635,00 TL
- 700,00 TL



14200.1223.8721.0
2 Şebeke + 3 UPS + 2 Cat6 + 1 Cat3
750,00 TL



14200.1233.8711.0
3 Şebeke + 3 UPS + 1 Cat6 + 1 Cat3
705,00 TL



14200.1232.8711.0
3 Şebeke + 2 UPS + 1 Cat6 + 1 Cat3
640,00 TL



14200.1222.8722.0
2 Şebeke + 2 UPS + 2 Cat6 + 2 Cat3
755,00 TL



14202.1050.000
5 Şebeke + Çift Sigortalı
700,00 TL



14200.1040.110
4 Şebeke + 2'li USB Şarj
660,00 TL



14300.1223.8721.0
2 Şebeke + 3 UPS + 2 Cat6 + 1 Cat3
840,00 TL







14300.1222.8722.0
2 Şebeke + 2 UPS + 2 Cat6 + 2 Cat3
830,00 TL

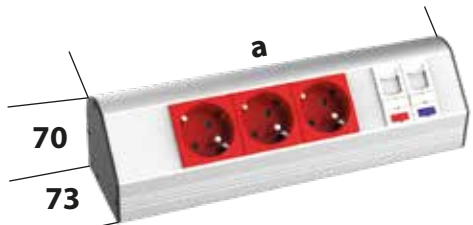

14300.1232.8711.0
3 Şebeke + 2 UPS + 1 Cat6 + 1 Cat3
755,00 TL

TEM G70 Masaüstü PDU

	Ürün Kodu	Açıklama	a (mm)	Fiyat
	17000.2030.8711.0	3 UPS + 1 Cat6 + 1 Cat3	280	550,00 TL
	17000.1222.8711.0	2 Şebeke + 2 UPS + 1 Cat6 + 1 Cat3	348	645,00 TL
	17000.2631.8711.0	3 UPS + 1 Üniversal Priz + 1 Cat6 + 1 Cat3	347,5	690,00 TL
	17000.2030.187111.0	3 UPS + 1 Cat6 + 1 Cat3 + 1 USB Şarj	302,5	675,00 TL

* a = yan kapaklar dahil toplam ürün ölçüsü

Montaj Ayağı

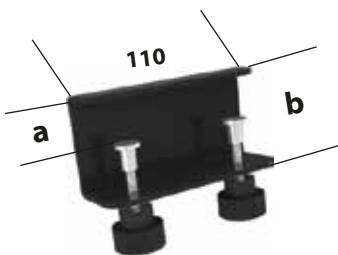

Ürün Kodu	Açıklama	a (mm)	b (mm)	Fiyat
740.050.030	Küçük Boy	$18 \leq a \leq 35$	56	200,00 TL
740.050.070	Büyük Boy	$35 \leq a \leq 75$	96	290,00 TL

* a = Masa kalınlığı ölçüsü

Kolon Kanal Modelleri

U62

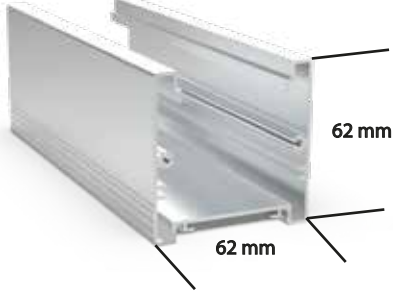

U62 Çiftli



H100

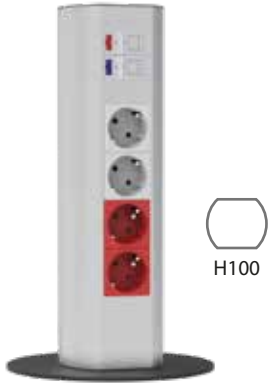

11400.1244.8722.0
4 Şebeke + 4 UPS +
2 Cat6 + 2 Cat3
1.100,00 TL



11400.1040.8142.0
4 Şebeke + 2x2'li USB Şarj
+ 4 Cat6
1.680,00 TL



11400.1020.135222.0
2 Şebeke + 2 USB Şarj +
2 VGA + 2 HDMI
1.740,00 TL



11400.1040.120
4 Şebeke
2x2'li USB Şarj
1.300,00 TL



11100.1233.8711.0
3 Şebeke + 3 UPS +
1 Cat 6 + 1 Cat 3
815,00 TL



11000.1244.136111.0
4 Şebeke + 4 UPS + 2 USB Şarj
+ 2 HDMI + 2 RCA
1.980,00 TL



1110.1222.8200.0
2 Şebeke + 2 UPS
2 Cat6
690,00 TL

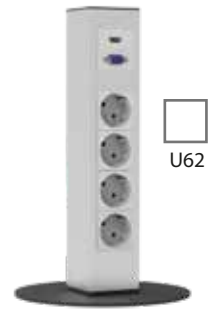

1110.1040.3511.0
4 Şebeke + 1 HDMI
+ 1 VGA
950,00 TL

TEM

Kolon Grubu

H100 Tavan Bağlantı Aparatı



H100 Kolon Ayağı



TEM 044 PDU

	Ürün Kodu	Açıklama	a (mm)	Fiyat
	11800.1020.210	2 Şebeke + 2'li USB Şarj	232	716,00 TL
	11800.2020.210	2 UPS + 2'li USB Şarj	232	724,00 TL
	11800.1030.000	3 Şebeke	205	435,00 TL
	11800.2030.000	3 UPS	205	445,00 TL
	11804.1020.210	2 Şebeke + 2'li USB Şarj + Gerilim Koruma	307	950,00 TL
	11804.2020.210	2 UPS + 2'li USB Şarj + Gerilim Koruma	307	960,00 TL
	11804.1030.000	3 Şebeke + Gerilim Koruma	280	635,00 TL
	11804.2030.000	3 UPS + Gerilim Koruma	280	646,00 TL



Kesim Ölçüsü
(Ø)60mm

Masa Kalınlığı
0 - 50mm

Kullanılmadıkça yer kaplamayan
grup priz
Özel kilit mekanizması



TEM Güç Çerçevesi

Boş Alüminyum Gövde

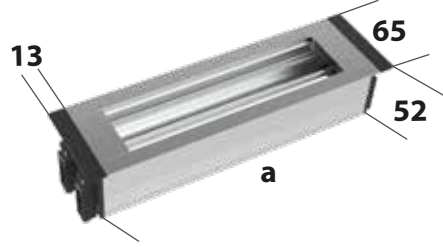

Ürün Kodu	Modül Sayısı (22,5)	Kesim Ölçüsü a+7(mm)	a (mm)	Fiyat
17200.0010.000	8 + 2 x 22.5	232 x 55	225	225,00 TL
17200.0012.000	10 + 2 x 22.5	277 x 55	270	255,00 TL
17200.0014.000	12 + 2 x 22.5	322 x 55	315	285,00 TL
17200.0016.000	14 + 2 x 22.5	367 x 55	360	315,00 TL

* a = yan kapaklar hariç net alüminyum ölçüsü
a+26 = Toplam ürün ölçüsü

Ürün Kodu	Açıklama	Kesim Ölçüsü a+6(mm)	a (mm)	Fiyat
-----------	----------	-------------------------	-----------	-------



17200.1020.110	2 Şebeke + USB Şarj	208,5 x 55	202,5	610,00 TL
17200.2030.8711.0	3 UPS + 1 Cat6 + 1 Cat3	276 x 55	270	550,00 TL
17200.4020.1511.0	2 İngiliz Prizi + 1 USB Şarj + VGA	243 x 55	225	860,00 TL
17200.1222.820.0	2 Şebeke + 2 UPS + 2 Cat6	343,5 x 55	337,5	640,00 TL



TEM Masa Kapağı

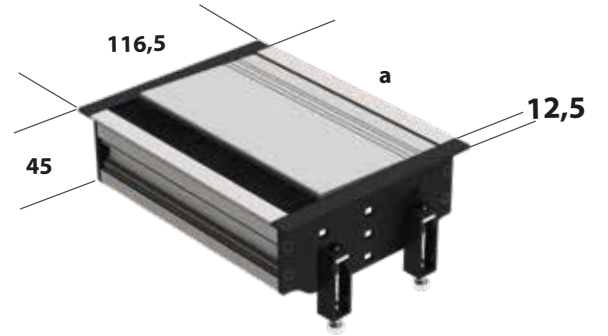
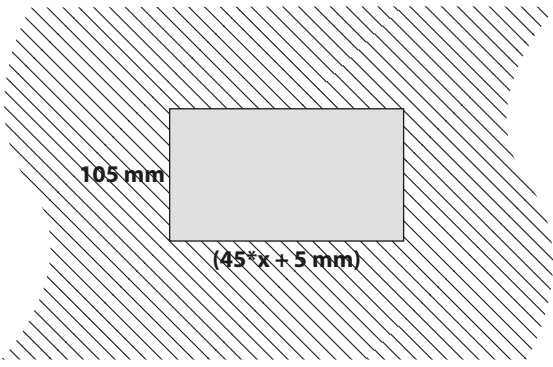

Boş Alüminyum Gövde

Ürün Kodu

Kesim Ölçüsü

(mm)

Fiyat



17100.0010.000

232x105

225

260,00 TL

17100.0012.000

277x105

270

295,00 TL

17100.0014.000

322x105

315

330,00 TL

17100.0016.000

367x105

360

365,00 TL



* a = yan kapaklar hariç net alüminyum ölçüsü
a+25 = Toplam ürün ölçüsü

TEM Kapaklı Güç Çerçevesi



Boş Alüminyum Gövde	Ürün Kodu	Modül Sayısı (22,5)	Kesim Ölçüsü a+35(mm)	a (mm)	Fiyat
	17300.0010.0	8 + 2 x 22.5	260x105	225	455,00 TL
	17300.0012.0	10 + 2 x 22.5	305x105	270	520,00 TL
	17300.0014.0	12 + 2 x 22.5	350x105	315	585,00 TL
	17300.0016.0	14 + 2 x 22.5	395x105	360	650,00 TL

* a = yan kapaklar hariç net alüminyum ölçüsü
a+56 = Toplam ürün ölçüsü

Örnek Ürünler	Ürün Kodu	Açıklama	Kesim Ölçüsü a+35(mm)	a (mm)	Fiyat
	17300.1020.110	2 Şebeke + 1 USB Şarj	260 x 105	225	870,00 TL
	17300.1020.8711.0	2 Şebeke + 1 Cat6 + 1 Cat3	237,5 x 105	202,5	750,00 TL
	17300.1222.8711.0	2 Şebeke + 2 UPS + 1 Cat6 + 1 Cat3	372,5 x 105	337,5	990,00 TL
	17300.1631.210	3 Şebeke + 1 Üniversal Priz +2'li USB Şarj	395 x 105	360	1530,00 TL



TEM Yatay Masa Grubu

Boş Alüminyum Gövde	Ürün Kodu	Modül Sayısı (22,5mm)	Kesim Ölçüsü a+70(mm)	^a (mm)	Fiyat
	17400.0010.000	8 + 2 x 22.5 Modül	295 x 135	225	690,00 TL
	17400.0012.000	10 + 2 x 22.5 Modül	340 x 135	270	740,00 TL
	17400.0014.000	12 + 2 x 22.5 Modül	385 x 135	315	790,00 TL
	17400.0016.000	14 + 2 x 22.5 Modül	430 x 135	360	840,00 TL

* **a** = Boş kanal içi kullanılabilirlik ölçüsü
a+70 = Ürün kesim ölçüsü
a+100 = Toplam ürün ölçüsü

Örnek Ürünler	Ürün Kodu	Açıklama	Kesim Ölçüsü a+70(mm)	^a (mm)	Fiyat
	17400.1040.820	4 Şebeke + 2 Cat6	362,5x135	292,5	1130,00 TL
	17400.1222.8711.0	2 Şebeke + 2 UPS + 1 Cat6 +1 Cat3	385x135	315	1100,00 TL
	17400.1224.842	2 Şebeke + 4 UPS + 4 Cat6 + Soket Girişli	520x135	450	1560,00 TL
	17400.1233.840	3 Şebeke + 3 UPS + 4 Cat6	520x135	450	1550,00 TL



Kontrol Seçenekleri

- PIR Hareket Sensörü
- IR Yaklaşım Kapı Sensörü
- IR Yaklaşım Aç Kapa
- Dokunmatik Aç Kapa
- Dokunmatik 3 Kademeli Dimmer
- On / Off Anahtar

TEM Aydınlatma

- Işık Rengi: 6500 K / 3000 K
- Giriş: 220 V Sürücülü
220 V Sürücüsüz
24 V Sürücüsüz
- Montaj: Askılı
Vidalı
Mıknatıslı

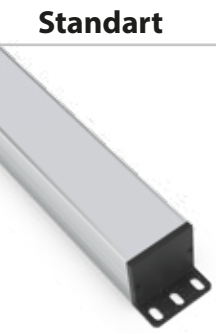

Standart

	Ürün Kodu	Açıklama	Mıknatıssız Fiyat	Mıknatıslı Fiyat
220 V Sürücüsüz	14005.10.3514.X1	35cm 14W 1m Kablolu	538,00 TL	663,00 TL
	14005.10.5518.X1	55cm 18W 1m Kablolu	695,00 TL	820,00 TL
220 V Sürücülü	14005.20.3508.X1	35cm 8,4W 1m Kablolu	445,00 TL	570,00 TL
	14005.20.5514.X1	55cm 14W 1m Kablolu	615,00 TL	740,00 TL
24 V Sürücüsüz	14005.40.3508.X1	35cm 8,4W 1m Kablolu	290,00 TL	415,00 TL
	14005.40.5514.X1	55cm 14W 1m Kablolu	415,00 TL	540,00 TL

X = 0 Mıknatıssız

X = 1 Mıknatıslı

On - Off Anahtarlı



	Ürün Kodu	Açıklama	Mıknatıssız Fiyat	Mıknatıslı Fiyat
220 V Sürücüsüz	14005.11.3514.X1	35cm 14W 1m Kablolu	558,00 TL	683,00 TL
	14005.11.5518.X1	55cm 18W 1m Kablolu	715,00 TL	840,00 TL
220 V Sürücülü	14005.21.3508.X1	35cm 8,4W 1m Kablolu	465,00 TL	590,00 TL
	14005.21.5514.X1	55cm 14W 1m Kablolu	635,00 TL	760,00 TL
24 V Sürücüsüz	14005.41.3508.X1	35cm 8,4W 1m Kablolu	310,00 TL	435,00 TL
	14005.41.5514.X1	55cm 14W 1m Kablolu	435,00 TL	560,00 TL

X = 0 Mıknatıssız

X = 1 Mıknatıslı

Dokunmatik Aç - Kapa



	Ürün Kodu	Açıklama	Mıknatıssız Fiyat	Mıknatıslı Fiyat
220 V Sürücüsüz	14005.12.3514.X1	35cm 14W 1m Kablolu	690,00 TL	815,00 TL
	14005.12.5518.X1	55cm 18W 1m Kablolu	845,00 TL	970,00 TL
220 V Sürücülü	14005.22.3508.X1	35cm 8,4W 1m Kablolu	595,00 TL	720,00 TL
	14005.22.5514.X1	55cm 14W 1m Kablolu	765,00 TL	890,00 TL
24 V Sürücüsüz	14005.42.3508.X1	35cm 8,4W 1m Kablolu	440,00 TL	565,00 TL
	14005.42.5514.X1	55cm 14W 1m Kablolu	565,00 TL	690,00 TL

X = 0 Mıknatıssız

X = 1 Mıknatıslı

PIR Hareket Sensörü



	Ürün Kodu	Açıklama	Mıknatıssız Fiyat	Mıknatıslı Fiyat
220 V Sürücülü	14005.23.3508.X1	35cm 8,4W 1m Kablolu	816,00 TL	941,00 TL
	14005.23.5514.X1	55cm 14W 1m Kablolu	986,00 TL	1.111,00 TL
24 V Sürücüsüz	14005.43.3508.X1	35cm 8,4W 1m Kablolu	661,00 TL	786,00 TL
	14005.43.5514.X1	55cm 14W 1m Kablolu	786,00 TL	911,00 TL

X = 0 Mıknatıssız

X = 1 Mıknatıslı

Yaklaşım Kapı Sensörü	Ürün Kodu	Açıklama	Mıknatıssız Fiyat	Mıknatıslı Fiyat
220 V Sürücülü	14005.24.3508.X1	35cm 8,4W 1m Kablolu	805,00 TL	930,00 TL
	14005.24.5514.X1	55cm 14W 1m Kablolu	975,00 TL	1.100,00 TL
24 V Sürücüsüz	14005.44.3508.X1	35cm 8,4W 1m Kablolu	650,00 TL	775,00 TL
	14005.44.5514.X1	55cm 14W 1m Kablolu	775,00 TL	900,00 TL
		X = 0 Mıknatıssız X = 1 Mıknatıslı		

3 Kademeli Dimmer	Ürün Kodu	Açıklama	Mıknatıssız Fiyat	Mıknatıslı Fiyat
220 V Sürücülü	14005.25.3508.X1	35cm 8,4W 1m Kablolu	595,00 TL	720,00 TL
	14005.25.5514.X1	55cm 14W 1m Kablolu	765,00 TL	890,00 TL
24 V Sürücüsüz	14005.45.3508.X1	35cm 8,4W 1m Kablolu	440,00 TL	565,00 TL
	14005.45.5514.X1	55cm 14W 1m Kablolu	565,00 TL	690,00 TL
		X = 0 Mıknatıssız X = 1 Mıknatıslı		

IR Yaklaşım Aç - Kapa	Ürün Kodu	Açıklama	Mıknatıssız Fiyat	Mıknatıslı Fiyat
220 V Sürücülü	14005.26.3508.X1	35cm 8,4W 1m Kablolu	805,00 TL	930,00 TL
	14005.26.5514.X1	55cm 14W 1m Kablolu	975,00 TL	1.100,00 TL
24 V Sürücüsüz	14005.46.3508.X1	35cm 8,4W 1m Kablolu	650,00 TL	775,00 TL
	14005.46.5514.X1	55cm 14W 1m Kablolu	775,00 TL	900,00 TL
		X = 0 Mıknatıssız X = 1 Mıknatıslı		

U20 Aydınlatma	Ürün Kodu	Açıklama	Mıknatıssız Fiyat	Mıknatıslı Fiyat
220 V	1200.27.3505.X1	220V 1m Kablolu + 35cm 5W	330,00 TL	350,00 TL
	1200.27.4106.X1	220V 1m Kablolu + 41cm 6W	360,00 TL	380,00 TL
	1200.27.5210.X1	220V 1m Kablolu + 52cm 10W	430,00 TL	455,00 TL
24V	1200.28.2004.X1	24V 1m Kablolu + 20cm 4.3W	340,00 TL	360,00 TL
	1200.28.3004.X1	24V 1m Kablolu + 30cm 4.3W	400,00 TL	420,00 TL
	1200.29.5007.X1	24V 1m Kablolu + 50cm 7.2W	580,00 TL	605,00 TL
	1200.29.10014.X1	24V 1m Kablolu + 100cm 14.1W	1.040,00 TL	1.090,00 TL
		X = 0 Mıknatıssız X = 1 Mıknatıslı		



TEM Linear Armatür

● Işık Rengi: 6500 K / 3000 K

● Giriş: 220 V Sürüclü
24 V Sürücüsüz

● Montaj: Askılı
Vidalı
Mıknatıslı

TİP 1U

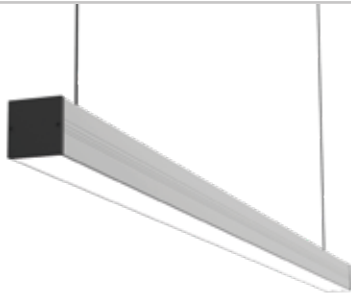

	Ürün Kodu	Açıklama	Fiyat
220 V Sürüclü	140025.20.6016	60cm 16,8W	805,00 TL
	140025.20.9025	90cm 25,2W	1.015,00 TL
	140025.20.12033	120cm 33,6W	1.230,00 TL
	140025.20.15042	150cm 42W	1.440,00 TL
24 V	140025.40.6016	60cm 16,8W	605,00 TL
	140025.40.9025	90cm 25,2W	820,00 TL
	140025.40.12033	120cm 33,6W	1.025,00 TL
	140025.40.15042	150cm 42W	1.250,00 TL

TİP C

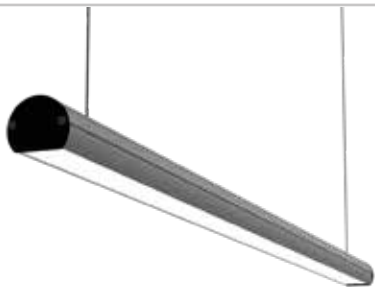

	Ürün Kodu	Açıklama	Fiyat
220 V Sürüclü	140425.20.6016	60cm 16,8W	825,00 TL
	140425.20.9025	90cm 25,2W	1.045,00 TL
	140425.20.12033	120cm 33,6W	1.270,00 TL
	140425.20.15042	150cm 42W	1.490,00 TL
24 V	140425.40.6016	60cm 16,8W	625,00 TL
	140425.40.9025	90cm 25,2W	850,00 TL
	140425.40.12033	120cm 33,6W	1.065,00 TL
	140425.40.15042	150cm 42W	1.300,00 TL

Yan Kapak Seçenekleri

Düz Yan Kapak
Vidalı Yan Kapak
Gst Soketli Yan Kapak

Opsiyonel Sinyal Led



Priz Seçenekleri

Şebeke
UPS
İngiliz
Fransız
IEC C13 / C19

Kontrol Seçenekleri

On / Off Anahtar
Sensör
Anahtar + Kumanda Kablosu

LED Seçenekleri

13 cm LED
30 cm LED
50 cm LED

TEM Prizli Aydınlatma

● Işık Rengi: 6500 K / 3000 K

● Giriş: 220 V Sürücülü
24 V Sürücüsüz

● Montaj: Vidalı
Mıknatıslı

Tip 1U



220 V Sürücüsüz

Ürün Kodu	Açıklama
14005.1013.1020.X0	2 Şebeke + 13cm LED
14005.1013.2020.X0	2 UPS + 13cm LED
14005.1030.1020.X0	2 Şebeke + 30cm LED
14005.1030.2020.X0	2 UPS + 30cm LED +

220 V Sürücülü

14005.2030.1020.X0	2 Şebeke + 30cm LED
14005.2030.2020.X0	2 UPS + 30cm LED

X = 0 Mıknatıssız

X = 1 Mıknatıslı

Mıknatıssız Fiyat

Mıknatıslı Fiyat

430,00 TL 555,00 TL

440,00 TL 565,00 TL

670,00 TL 795,00 TL

680,00 TL 805,00 TL

620,00 TL 745,00 TL

630,00 TL 755,00 TL

Tip G70



220 V Sürücüsüz

Ürün Kodu	Açıklama
17005.1030.1020.0	2 Şebeke + 30cm LED
17005.1030.1040.0	4 Şebeke + 30cm LED
17005.1050.1020.0	2 Şebeke + 50cm LED
17005.1050.1040.0	4 Şebeke + 50cm LED

220 V Sürücülü

17005.2030.1020.0	2 Şebeke + 30cm LED
17005.2030.1040.0	4 Şebeke + 30cm LED
17005.2050.1020.0	2 Şebeke + 50cm LED
17005.2050.1040.0	4 Şebeke + 50cm LED

Fiyat

770,00 TL

870,00 TL

975,00 TL

1.075,00 TL

680,00 TL

780,00 TL

850,00 TL

950,00 TL

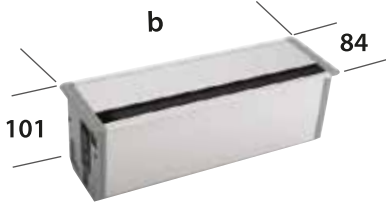

Ürün Kodu	Modül	b	Fiyat
810.020.01X	2x45	132	560,00 TL
810.030.01X	3x45	171	680,00 TL
810.040.01X	4x45	238	815,00 TL
810.050.01X	5x45	279	920,00 TL
810.060.01X	6x45	342	1.030,00 TL
810.070.01X	7x45	387	1.110,00 TL
810.080.01X	8x45	449	1.190,00 TL
810.090.01X	9x45	474	1.275,00 TL
810.0100.01X	10x45	534	1.335,00 TL

X = 1 Eloksal X = 3 Siyah X = 6 Beyaz

Tüm ölçüler mm cinsindedir.



Döşeme Altı Buat

650,00 TL

Döşeme Altı Priz Kutusu(Boş Kutu)
Kapasite 18 Adet 22.5 Modül

590,00 TL

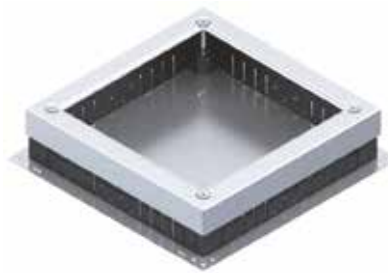

205.352.000



206.252.000

Ürün Kodu	Ölçü(mm)	Ağırlık(Kg)
205.352.000	352x352	2.563
206.252.000	252x252	1.461



113x210mm Dahili Priz Kutuları



210.0000.0000
113x210x70mm
95,00 TL



210.1200.4400
4 Şebeke + 4 UPS
385,00 TL



212.1000.6000
6 Şebeke + 2'li Sigorta Yeri
273,00 TL

210x280mm Dahili Priz Kutuları



280.0000.0000
210x280x70mm
160,00 TL



280.1200.6600
6 Şebeke + 6 UPS
560,00 TL



282.1200.6300
6 Şebeke + 3 UPS + 2'li Sigorta Yeri
460,00 TL



3 Kutup

16A

4h

2P+E

IP44

110-130 V~



444.316.150
Pano Prizi
95,00 TL



444.316.151
Dik Kasalı Duvar Prizi
127,00 TL



444.316.152
Eğik Kasalı Duvar Prizi
130,00 TL



444.316.200
Seyyar Priz
110,00 TL



444.316.300
Fiş
85,00 TL

3 Kutup

16A

6h

2P+E

IP44

200-250 V~



446.316.150
Pano Prizi
95,00 TL



446.316.151
Dik Kasalı Duvar Prizi
127,00 TL



446.316.152
Eğik Kasalı Duvar Prizi
130,00 TL



446.316.153
Eğik Kasalı Duvar Prizi + Monofaze Priz
188,00 TL



446.316.200
Seyyar Priz
110,00 TL



446.316.300
Fiş
85,00 TL

3 Kutup

32A

6h

2P+E

200-250 V~



446.332.150
IP44 Pano Prizi
110,00 TL



446.332.151
IP44 Dik Kasalı Duvar Prizi
163,00 TL



446.332.400
IP44 Eğik Duvar Prizi
160,00 TL



446.332.200
IP44 Seyyar Priz
135,00 TL



446.332.300
IP44 Fiş
120,00 TL



676.332.150
IP67 Kilitli Kapaklı Pano Prizi
130,00 TL



676.332.151
Kilitli Kapaklı Dik Kasalı Duvar Prizi
180,00 TL



676.332.300
Kilitli Fiş
140,00 TL

4 Kutup

16A

6h

3P+E

380-415 V~



446.416.150 
IP44 Pano Prizi
105,00 TL



446.416.160 
IP44 Pano Prizi
110,00 TL



446.416.151 
IP44 Dik Kasalı Duvar Prizi
140,00 TL



446.416.152 
IP44 Eğik Kasalı Duvar Prizi
150,00 TL



446.416.153 
IP44 Eğik Kasalı Duvar Prizi
+ Monofaze Priz
195,00 TL



446.416.200 
IP44 Seyyar Priz
115,00 TL



446.416.300 
IP44 Fiş
95,00 TL



676.416.160 
IP67 Kilitli Kapaklı Pano Prizi
150,00 TL



676.416.161 
Kilitli Kapaklı Dik Kasalı Duvar Prizi
220,00 TL



676.416.200 
Kilitli Kapaklı Seyyar Priz
155,00 TL



676.416.300 
Kilitli Fiş
125,00 TL

4 Kutup

32A

6h

3P+E

380-415 V~



446.432.150 
IP44 Pano Prizi
145,00 TL



446.432.151 
IP44 Dik Kasalı Duvar Prizi
215,00 TL



446.432.400 
IP44 Eğik Duvar Prizi
185,00 TL



446.432.200 
IP44 Seyyar Priz
170,00 TL



446.432.300 
IP44 Fiş
135,00 TL



446.432.330 
IP44 Makine
Fişi
110,00 TL



446.432.331 
IP44 Düz
Kasalı Makine Fişi
140,00 TL



446.432.332 
IP44 Eğik Kasalı
Makine Fişi
180,00 TL



446.432.333 
IP44 Eğik Kasalı Makine Fişi
+ Monofaze Pano Prizi
198,00 TL

4 Kutup

32A

6h

3P+E

380-415 V~



676.432.150 
IP67 Kilitli Kapaklı Pano Prizi
170,00 TL



676.432.151 
IP67 Kilitli Kapaklı Dik Kasalı Duvar Prizi
250,00 TL



676.432.300 
IP67 Kilitli Fiş
180,00 TL

4 Kutup

63A

6h

3P+E

380-415 V~



446.463.150 
IP44 Pano Prizi
375,00 TL



446.463.200 
IP44 Seyyar Priz
400,00 TL



446.463.300 
IP44 Fiş
395,00 TL



676.463.150 
IP67 Kilitli Kapaklı Pano Prizi
395,00 TL



676.463.200 
IP67 Kilitli Seyyar Priz
430,00 TL



676.463.300 
IP67 Kilitli Fiş
415,00 TL

5 Kutup

16A

6h

3P+N+E

380-415 V~



446.516.150 
IP44 Pano Prizi
115,00 TL



446.516.151 
IP44 Dik Kasalı Duvar Prizi
165,00 TL



446.516.152 
IP44 Eğik Kasalı Duvar Prizi
183,00 TL



446.516.153 
IP44 Eğik Kasalı Duvar Prizi
+ Monofaze Priz
210,00 TL



446.516.400 
IP44 Eğik Duvar Prizi
130,00 TL



446.516.200 
IP44 Seyyar Priz
110,00 TL



446.516.300 
IP44 Fiş
107,00 TL



446.516.320 
IP44 Eğik Fiş
115,00 TL

5 Kutup

16A

6h

3P+N+E

380-415 V~



446.516.330 
IP44 Makine Fişi
110,00 TL



446.516.331 
IP44 Düz Kasalı Makine Fişi
150,00 TL

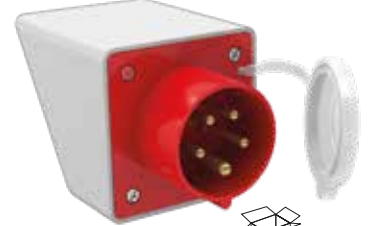

446.516.332 
IP44 Eğik Kasalı Makine Fişi
170,00 TL

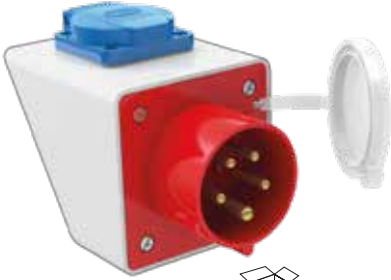

446.516.333 
IP44 Eğik Kasalı Makine Fişi
+ Monofaze Pano Prizi
205,00 TL



676.516.150 
IP67 Kilitli Kapaklı Pano Prizi
145,00 TL



676.516.151 
Kilitli Kapaklı Dik Kasalı Duvar Prizi
185,00 TL



676.516.152 
Kilitli Kapaklı Eğik Kasalı
Duvar Prizi
225,00 TL



676.516.153 
Kilitli Kapaklı Eğik Kasalı Duvar Prizi
+ Monofaze Pano Prizi
250,00 TL



676.516.300 
Kilitli Fiş
130,00 TL

5 Kutup

32A

6h

3P+N+E

380-415 V~



446.532.150 
IP44 Pano Prizi
170,00 TL



446.532.151 
IP44 Dik Kasalı Duvar Prizi
199,00 TL



446.532.200 
IP44 Seyyar Priz
190,00 TL



446.532.300 
IP44 Fiş
169,00 TL

5 Kutup

32A

6h

3P+N+E

380-415 V~



446.532.330 
IP44 Makine Fişi
143,00 TL



446.532.331 
IP44 Düz Kasalı Makine Fişi
170,00 TL



446.532.332 
IP44 Eğik Kasalı Makine Fişi
225,00 TL



446.532.333 
IP44 Eğik Kasalı Makine Fişi
+ Monofaze Pano Prizi
275,00 TL



676.532.150 
IP67 Kilitli Kapaklı Pano Prizi
190,00 TL



676.532.151 
Kilitli Kapaklı Dik Kasalı Duvar Prizi
225,00 TL



676.532.300 
Kilitli Fiş
183,00 TL

5 Kutup

63A

6h

3P+N+E

380-415 V~



446.563.150 
IP44 Pano Prizi
425,00 TL



446.563.200 
IP44 Seyyar Priz
450,00 TL



446.563.300 
IP44 Fiş
445,00 TL



676.563.150 
IP67 Kilitli Kapaklı Pano Prizi
450,00 TL



676.563.200 
IP67 Kilitli Seyyar Priz
475,00 TL



676.563.300 
IP67 Kilitli Fiş
470,00 TL

Seyyar 3'lü Çoklayıcı Prizler (Fiş Girişli)

IP44

6h

50/60 Hz.



Ürün Kodu	Kutup	I(A)	Volt	Renk		Fiyat
1344.316.333.0	2P+E	16	200-250	◆	2	750,00 TL
1344.332.333.0	2P+E	32	200-250	◆	4	1.500,00 TL
1344.416.333.0	3P+E	16	380-415	◆	2	850,00 TL
1344.432.333.0	3P+E	32	380-415	◆	2	1.600,00 TL
1344.516.333.0	3P+N+E	16	380-415	◆	2	950,00 TL
1344.532.333.0	3P+N+E	32	380-415	◆	2	1.700,00 TL

Seyyar 3'lü Çoklayıcı Prizler (Fiş Girişli)

IP67

6h

50/60 Hz.



Ürün Kodu	Kutup	I(A)	Volt	Renk		Fiyat
1367.316.333.0	2P+E	16	200-250	◆	2	1.100,00 TL
1367.332.333.0	2P+E	32	200-250	◆	4	1.650,00 TL
1367.416.333.0	3P+E	16	380-415	◆	2	1.200,00 TL
1367.432.333.0	3P+E	32	380-415	◆	2	1.750,00 TL
1367.516.333.0	3P+N+E	16	380-415	◆	2	1.300,00 TL
1367.532.333.0	3P+N+E	32	380-415	◆	2	1.850,00 TL

Seyyar 3'lü Çoklayıcı Prizler (Rekor Girişli)

IP44

6h

50/60 Hz.



Ürün Kodu	Kutup	I(A)	Volt	Renk		Fiyat
1344.316.333.1	2P+E	16	200-250	◆	2	700,00 TL
1344.332.333.1	2P+E	32	200-250	◆	4	1.100,00 TL
1344.416.333.1	3P+E	16	380-415	◆	2	800,00 TL
1344.432.333.1	3P+E	32	380-415	◆	2	1.200,00 TL
1344.516.333.1	3P+N+E	16	380-415	◆	4	900,00 TL
1344.532.333.1	3P+N+E	32	380-415	◆	4	1.300,00 TL

Seyyar 3'lü Çoklayıcı Prizler (Rekor Girişli)

IP67

6h

50/60 Hz.



Ürün Kodu	Kutup	I(A)	Volt	Renk		Fiyat
1367.316.333.1	2P+E	16	200-250	◆	2	1.000,00 TL
1367.332.333.1	2P+E	32	200-250	◆	4	1.300,00 TL
1367.416.333.1	3P+E	16	380-415	◆	2	1.100,00 TL
1367.432.333.1	3P+E	32	380-415	◆	2	1.400,00 TL
1367.516.333.1	3P+N+E	16	380-415	◆	4	1.200,00 TL
1367.532.333.1	3P+N+E	32	380-415	◆	4	1.500,00 TL

Dik Pano Prizleri (75x75)



Ürün Kodu	Kutup	I(A)	h	Volt	Renk		Fiyat
444.316.180	2P+E	16	4	110-130	◆	12	110,00 TL
446.316.180	2P+E	16	6	200-250	◆	12	95,00 TL
446.332.180	2P+E	32	6	200-250	◆	5	150,00 TL
446.416.180	3P+E	16	6	380-415	◆	10	110,00 TL
446.432.180	3P+E	32	6	380-415	◆	5	165,00 TL
446.516.180	3P+N+E	16	6	380-415	◆	12	130,00 TL
446.532.180	3P+N+E	32	6	380-415	◆	12	180,00 TL

Eğik Pano Prizleri



Ürün Kodu	Kutup	I(A)	h	Volt	Renk		Fiyat
444.316.190	2P+E	16	4	110-130	◆	10	115,00 TL
446.316.190	2P+E	16	6	200-250	◆	10	105,00 TL
446.332.190	2P+E	32	6	200-250	◆	5	160,00 TL
446.416.190	3P+E	16	6	380-415	◆	10	120,00 TL
446.432.190	3P+E	32	6	380-415	◆	5	175,00 TL
446.516.190	3P+N+E	16	6	380-415	◆	12	140,00 TL
446.532.190	3P+N+E	32	6	380-415	◆	5	190,00 TL

Seyyar Prizler



Ürün Kodu	Kutup	I(A)	h	Volt	Renk		Fiyat
444.316.240	2P+E	16	4	110-130	◆	12	118,00 TL
446.316.240	2P+E	16	6	200-250	◆	12	100,00 TL
446.332.240	2P+E	32	6	200-250	◆	4	150,00 TL
446.416.240	3P+E	16	6	380-415	◆	10	125,00 TL
446.432.240	3P+E	32	6	380-415	◆	4	170,00 TL
446.516.240	3P+N+E	16	6	380-415	◆	12	140,00 TL
446.532.240	3P+N+E	32	6	380-415	◆	12	180,00 TL

Seyyar Fişler



Ürün Kodu	Kutup	I(A)	h	Volt	Renk		Fiyat
444.316.340	2P+E	16	4	110-130	◆	12	86,00 TL
446.316.340	2P+E	16	6	200-250	◆	12	75,00 TL
446.332.340	2P+E	32	6	200-250	◆	5	115,00 TL
446.416.340	3P+E	16	6	380-415	◆	10	90,00 TL
446.432.340	3P+E	32	6	380-415	◆	5	130,00 TL
446.516.340	3P+N+E	16	6	380-415	◆	12	105,00 TL
446.532.340	3P+N+E	32	6	380-415	◆	12	140,00 TL

Eğik Duvar Prizleri



Ürün Kodu	Kutup	I(A)	h	Volt	Renk		Fiyat
444.316.410	2P+E	16	4	110-130	◆	10	178,00 TL
446.316.410	2P+E	16	6	200-250	◆	10	155,00 TL
446.332.410	2P+E	32	6	200-250	◆	2	195,00 TL
446.416.410	3P+E	16	6	380-415	◆	3	170,00 TL
446.432.410	3P+E	32	6	380-415	◆	2	210,00 TL
446.516.410	3P+N+E	16	6	380-415	◆	10	185,00 TL
446.532.410	3P+N+E	32	6	380-415	◆	6	220,00 TL

Dik Pano Prizleri (75x75)

IP67

6h

50/60 Hz.



Ürün Kodu	Kutup	I(A)	h	Volt	Renk		Fiyat
674.316.180	2P+E	16	4	110-130	◆	12	195,00 TL
676.316.180	2P+E	16	6	200-250	◆	12	170,00 TL
676.332.180	2P+E	32	6	200-250	◆	5	200,00 TL
676.416.180	3P+E	16	6	380-415	◆	8	180,00 TL
676.432.180	3P+E	32	6	380-415	◆	5	220,00 TL
676.516.180	3P+N+E	16	6	380-415	◆	10	190,00 TL
676.532.180	3P+N+E	32	6	380-415	◆	12	260,00 TL

Eğik Pano Prizleri



Ürün Kodu	Kutup	I(A)	h	Volt	Renk		Fiyat
674.316.190	2P+E	16	4	110-130	◆	10	205,00 TL
676.316.190	2P+E	16	6	200-250	◆	10	180,00 TL
676.332.190	2P+E	32	6	200-250	◆	5	210,00 TL
676.416.190	3P+E	16	6	380-415	◆	8	190,00 TL
676.432.190	3P+E	32	6	380-415	◆	5	230,00 TL
676.516.190	3P+N+E	16	6	380-415	◆	8	200,00 TL
676.532.190	3P+N+E	32	6	380-415	◆	5	270,00 TL

Seyyar Prizler



Ürün Kodu	Kutup	I(A)	h	Volt	Renk		Fiyat
674.316.240	2P+E	16	4	110-130	◆	12	195,00 TL
676.316.240	2P+E	16	6	200-250	◆	12	170,00 TL
676.332.240	2P+E	32	6	200-250	◆	4	250,00 TL
676.416.240	3P+E	16	6	380-415	◆	8	205,00 TL
676.432.240	3P+E	32	6	380-415	◆	4	270,00 TL
676.516.240	3P+N+E	16	6	380-415	◆	12	220,00 TL
676.532.240	3P+N+E	32	6	380-415	◆	12	290,00 TL

Seyyar Fişler



Ürün Kodu	Kutup	I(A)	h	Volt	Renk		Fiyat
674.316.340	2P+E	16	4	110-130	◆	12	138,00 TL
676.316.340	2P+E	16	6	200-250	◆	12	120,00 TL
676.332.340	2P+E	32	6	200-250	◆	4	195,00 TL
676.416.340	3P+E	16	6	380-415	◆	8	150,00 TL
676.432.340	3P+E	32	6	380-415	◆	4	215,00 TL
676.516.340	3P+N+E	16	6	380-415	◆	12	195,00 TL
676.532.340	3P+N+E	32	6	380-415	◆	12	250,00 TL

Eğik Duvar Prizleri



Ürün Kodu	Kutup	I(A)	h	Volt	Renk		Fiyat
674.316.410	2P+E	16	4	110-130	◆	10	283,00 TL
676.316.410	2P+E	16	6	200-250	◆	10	220,00 TL
676.332.410	2P+E	32	6	200-250	◆	2	295,00 TL
676.416.410	3P+E	16	6	380-415	◆	3	250,00 TL
676.432.410	3P+E	32	6	380-415	◆	2	315,00 TL
676.516.410	3P+N+E	16	6	380-415	◆	10	295,00 TL
676.532.410	3P+N+E	32	6	380-415	◆	6	350,00 TL

İçten Kilitli Şalterli Pano Prizi (Yatay Tip)

IP44

6h

50/60 Hz.



Ürün Kodu	Kutup	I(A)	Volt	Renk		Fiyat
1444.316.15	2P+E	16	200-250	◆	1	875,70 TL
1444.332.15	2P+E	32	200-250	◆	1	945,00 TL
1444.416.15	3P+E	16	380-415	◆	1	891,00 TL
1444.432.15	3P+E	32	380-415	◆	1	1.107,00 TL
1444.516.15	3P+N+E	16	380-415	◆	1	1.026,00 TL
1444.532.15	3P+N+E	32	380-415	◆	1	1.155,60 TL

İçten Kilitli Şalterli Pano Prizi (Yatay Tip)

IP67

6h

50/60 Hz.



Ürün Kodu	Kutup	I(A)	Volt	Renk		Fiyat
1467.316.15	2P+E	16	200-250	◆	1	1.224,00 TL
1467.332.15	2P+E	32	200-250	◆	1	1.386,00 TL
1467.416.15	3P+E	16	380-415	◆	1	1.260,00 TL
1467.432.15	3P+E	32	380-415	◆	1	1.449,00 TL
1467.516.15	3P+N+E	16	380-415	◆	1	1.386,00 TL
1467.532.15	3P+N+E	32	380-415	◆	1	1.638,00 TL

İçten Kilitli Şalterli Duvar Prizi (Yatay Tip)

IP44

6h

50/60 Hz.



Ürün Kodu	Kutup	I(A)	Volt	Renk		Fiyat
1444.316.10	2P+E	16	200-250	◆	1	1.071,00 TL
1444.332.10	2P+E	32	200-250	◆	1	1.090,00 TL
1444.416.10	3P+E	16	380-415	◆	1	1.120,00 TL
1444.432.10	3P+E	32	380-415	◆	1	1.134,00 TL
1444.516.10	3P+N+E	16	380-415	◆	1	1.130,00 TL
1444.532.10	3P+N+E	32	380-415	◆	1	1.188,00 TL

İçten Kilitli Şalterli Duvar Prizi (Yatay Tip)

IP67

6h

50/60 Hz.



Ürün Kodu	Kutup	I(A)	Volt	Renk		Fiyat
1467.316.10	2P+E	16	200-250	◆	1	1.476,00 TL
1467.332.10	2P+E	32	200-250	◆	1	1.510,00 TL
1467.416.10	3P+E	16	380-415	◆	1	1.490,00 TL
1467.432.10	3P+E	32	380-415	◆	1	1.590,00 TL
1467.516.10	3P+N+E	16	380-415	◆	1	1.512,00 TL
1467.532.10	3P+N+E	32	380-415	◆	1	1.650,00 TL

İçten Kilitli Şalterli Pano Prizi (Dikey Tip)

IP44

6h

50/60 Hz.



Ürün Kodu	Kutup	I(A)	Volt	Renk		Fiyat
1944.316.15	2P+E	16	200-250	◆	1	920,00 TL
1944.332.15	2P+E	32	200-250	◆	1	992,00 TL
1944.416.15	3P+E	16	380-415	◆	1	935,00 TL
1944.432.15	3P+E	32	380-415	◆	1	1.162,00 TL
1944.516.15	3P+N+E	16	380-415	◆	1	1.077,00 TL
1944.532.15	3P+N+E	32	380-415	◆	1	1.213,00 TL

İçten Kilitli Şalterli Pano Prizi (Dikey Tip)

IP67

6h

50/60 Hz.



Ürün Kodu	Kutup	I(A)	Volt	Renk		Fiyat
1967.316.15	2P+E	16	200-250	◆	1	1.285,00 TL
1967.332.15	2P+E	32	200-250	◆	1	1.455,00 TL
1967.416.15	3P+E	16	380-415	◆	1	1.325,00 TL
1967.432.15	3P+E	32	380-415	◆	1	1.521,00 TL
1967.516.15	3P+N+E	16	380-415	◆	1	1.455,00 TL
1967.532.15	3P+N+E	32	380-415	◆	1	1.719,00 TL

İçten Kilitli Şalterli Duvar Prizi (Dikey Tip)

IP44

6h

50/60 Hz.



Ürün Kodu	Kutup	I(A)	Volt	Renk		Fiyat
1944.316.10	2P+E	16	200-250	◆	1	1.124,00 TL
1944.332.10	2P+E	32	200-250	◆	1	1.144,00 TL
1944.416.10	3P+E	16	380-415	◆	1	1.176,00 TL
1944.432.10	3P+E	32	380-415	◆	1	1.190,00 TL
1944.516.10	3P+N+E	16	380-415	◆	1	1.186,00 TL
1944.532.10	3P+N+E	32	380-415	◆	1	1.247,00 TL

İçten Kilitli Şalterli Duvar Prizi (Dikey Tip)

IP67

6h

50/60 Hz.



Ürün Kodu	Kutup	I(A)	Volt	Renk		Fiyat
1967.316.10	2P+E	16	200-250	◆	1	1.549,00 TL
1967.332.10	2P+E	32	200-250	◆	1	1.585,00 TL
1967.416.10	3P+E	16	380-415	◆	1	1.565,00 TL
1967.432.10	3P+E	32	380-415	◆	1	1.670,00 TL
1967.516.10	3P+N+E	16	380-415	◆	1	1.587,00 TL
1967.532.10	3P+N+E	32	380-415	◆	1	1.732,00 TL

İçten Kilitli Şalterli Sigortalı Pano Prizi

IP44

6h

50/60 Hz.



Ürün Kodu	Kutup	I(A)	Volt	Renk		Fiyat
1644.316.15	2P+E	16	200-250	◆	1	1.230,00 TL
1644.332.15	2P+E	32	200-250	◆	1	1.380,00 TL
1644.416.15	3P+E	16	380-415	◆	1	1.340,00 TL
1644.432.15	3P+E	32	380-415	◆	1	1.521,00 TL
1644.516.15	3P+N+E	16	380-415	◆	1	1.445,00 TL
1644.532.15	3P+N+E	32	380-415	◆	1	1.617,00 TL

İçten Kilitli Şalterli Sigortalı Pano Prizi

IP67

6h

50/60 Hz.



Ürün Kodu	Kutup	I(A)	Volt	Renk		Fiyat
1667.316.15	2P+E	16	200-250	◆	1	1.285,00 TL
1667.332.15	2P+E	32	200-250	◆	1	1.430,00 TL
1667.416.15	3P+E	16	380-415	◆	1	1.390,00 TL
1667.432.15	3P+E	32	380-415	◆	1	1.570,00 TL
1667.516.15	3P+N+E	16	380-415	◆	1	1.497,00 TL
1667.532.15	3P+N+E	32	380-415	◆	1	1.665,00 TL

İçten Kilitli Şalterli Sigortalı Duvar Prizi

IP44

6h

50/60 Hz.



Ürün Kodu	Kutup	I(A)	Volt	Renk		Fiyat
1644.316.10	2P+E	16	200-250	◆	1	1.390,00 TL
1644.332.10	2P+E	32	200-250	◆	1	1.521,00 TL
1644.416.10	3P+E	16	380-415	◆	1	1.497,00 TL
1644.432.10	3P+E	32	380-415	◆	1	1.665,00 TL
1644.516.10	3P+N+E	16	380-415	◆	1	1.605,00 TL
1644.532.10	3P+N+E	32	380-415	◆	1	1.760,00 TL

İçten Kilitli Şalterli Sigortalı Duvar Prizi

IP67

6h

50/60 Hz.



Ürün Kodu	Kutup	I(A)	Volt	Renk		Fiyat
1667.316.10	2P+E	16	200-250	◆	1	1.445,00 TL
1667.332.10	2P+E	32	200-250	◆	1	1.605,00 TL
1667.416.10	3P+E	16	380-415	◆	1	1.551,00 TL
1667.432.10	3P+E	32	380-415	◆	1	1.721,00 TL
1667.516.10	3P+N+E	16	380-415	◆	1	1.660,00 TL
1667.532.10	3P+N+E	32	380-415	◆	1	1.810,00 TL

260x350mm Priz Montajlı Sigortalı Kombinasyon Kutuları (12 Sigorta Kapasiteli)

HALOJEN FREE

Ürün Kodu	IP44 Kombinasyon Kutuları		Fiyat
44120	260x350x120mm IP44 Boş Kombinasyon Kutusu	1	390,00 TL
44120.4160.1160.224	2 Ad. IP44 4x16A CEE + 2 Ad. IP44 1x16A Ön + 4 Ad. IP44 1x16A Yan	1	882,00 TL
44120.4160.0000.042	4 Ad. IP44 4x16A CEE Ön + 2 Ad.1x16 Yan	1	912,00 TL
44120.3163.0000.044	4 Ad. IP44 3x16A Ön + 4 Ad. 1x16 Yan	1	862,00 TL
44120.3323.3163.224	2 Ad. IP44 3x32A Ön + 2 Ad. IP44 3x16 Ön + 4 Ad. 1x16A Yan	1	902,00 TL
44120.3323.0000.044	4 Ad. IP44 3x32A Ön + 4 Ad. 1x16A Yan	1	942,00 TL
44120.4320.4250.222	2 Ad. IP44 4x32A CEE Ön + 2 Ad. IP44 4x25A Ön + 2 Ad. 1x16A Yan	1	892,00 TL
44120.4250.0000.044	4 Ad. IP44 4x25A Ön + 4 Ad. 1x16A Yan	1	814,00 TL
44120.4320.0000.046	4 Ad. IP44 4x32A CEE Ön + 6 Ad. 1x16A Yan	1	1.216,00 TL
44120.4321.0000.044	4 Ad. IP67 4x32A CEE Ön + 4 Ad. 1x16A Yan	1	1.234,00 TL
44120.4631.4321.222	2 Ad. IP67 4x63A CEE Ön + 2 Ad. IP67 4x32A CEE Ön + 2 Ad. 1x16 Yan	1	1.602,00 TL
44120.4630.0000.028	2 Ad. IP44 4x63A CEE Ön + 4 Ad. 1x16A Ön + 4 Ad. 1x16 Yan	1	1.468,00 TL
44120.5320.5160.222	2 Ad. IP44 5x32A CEE Ön + 2 Ad. IP44 5x16A CEE Ön + 2 Ad. 1x16 Yan	1	1.042,00 TL
44120.5321.0000.046	4 Ad. IP67 5x32A CEE Ön + 6 Ad. 1x16A Yan	1	1.396,00 TL
44120.5631.5321.222	2 Ad. IP67 5x63A CEE Ön + 2 Ad. IP67 5x32A CEE Ön + 2 Ad. 1x16A Yan	1	1.752,00 TL

Ürün Kodu	IP67 Kombinasyon Kutuları		Fiyat
64120	260x350x120mm IP67 Boş Kombinasyon Kutusu	1	420,00 TL
64120.4160.1160.224	2 Ad. IP44 4x16A CEE + 2 Ad. IP44 1x16A Ön + 4 Ad. IP44 1x16A Yan	1	912,00 TL
64120.4160.0000.042	4 Ad. IP44 4x16A CEE Ön + 2 Ad. 1x16 Yan	1	942,00 TL
64120.3163.0000.044	4 Ad. IP44 3x16A Ön + 4 Ad. 1x16 Yan	1	892,00 TL
64120.3323.3163.224	2 Ad. IP44 3x32A Ön + 2 Ad. IP44 3x16 Ön + 4 Ad. 1x16A Yan	1	932,00 TL
64120.3323.0000.044	4 Ad. IP44 3x32A Ön + 4 Ad. 1x16A Yan	1	972,00 TL
64120.4320.4250.222	2 Ad. IP44 4x32A CEE Ön + 2 Ad. IP44 4x25A Ön + 2 Ad. 1x16A Yan	1	922,00 TL
64120.4250.0000.044	4 Ad. IP44 4x25A Ön + 4 Ad. 1x16A Yan	1	844,00 TL
64120.4320.0000.046	4 Ad. IP44 4x32A CEE Ön + 6 Ad. 1x16A Yan	1	1.246,00 TL
64120.4321.0000.044	4 Ad. IP67 4x32A CEE Ön + 4 Ad. 1x16A Yan	1	1.264,00 TL
64120.4631.4321.222	2 Ad. IP67 4x63A CEE Ön + 2 Ad. IP67 4x32A CEE Ön + 2 Ad. 1x16 Yan	1	1.632,00 TL
64120.4630.0000.028	2 Ad. IP44 4x63A CEE Ön + 4 Ad. 1x16A Ön + 4 Ad. 1x16 Yan	1	1.498,00 TL
64120.5320.5160.222	2 Ad. IP44 5x32A CEE Ön + 2 Ad. IP44 5x16A CEE Ön + 2 Ad. 1x16 Yan	1	1.072,00 TL
64120.5321.0000.046	4 Ad. IP67 5x32A CEE Ön + 6 Ad. 1x16A Yan	1	1.426,00 TL
64120.5631.5321.222	2 Ad. IP67 5x63A CEE Ön + 2 Ad. IP67 5x32A CEE Ön + 2 Ad. 1x16A Yan	1	1.782,00 TL



44120



64120.4160.0000.028



64120.4160.3160.224



64120.5320.5160.224



64120.4321.5321.222

210x280mm Priz Montajlı Sigortalı Kombinasyon Kutuları (10 Sigorta Kapasiteli - Halojen Free)

Ürün Kodu	IP44 Kombinasyon Kutuları		Fiyat
42100	210x280x100mm IP44 Boş Kombinasyon Kutusu	1	270,00 TL
42100.4160.0000.011	1 Ad. IP44 4x16A CEE Ön + 1 Ad. 1x16A Ön	1	420,00 TL
42100.4160.0000.012	1 Ad. IP44 4x16A CEE Ön + 2 Ad. 1x16A Ön	1	464,00 TL
42100.4160.0000.022	2 Ad. IP44 4x16A CEE Ön + 2 Ad. 1x16A Yan	1	585,00 TL
42100.4250.0000.021	2 Ad. IP44 4x25A Ön + 1 Ad. 1x16A Yan	1	441,00 TL
42100.4250.0000.022	2 Ad. IP44 4x25A Ön + 2 Ad. 1x16A Yan	1	486,00 TL
42100.4320.0000.022	2 Ad. IP44 4x32A CEE Ön + 2 Ad. 1x16A Yan	1	662,00 TL
42100.4321.0000.024	2 Ad. IP67 4x32A CEE Ön + 4 Ad. 1x16A Yan	1	807,00 TL
42100.5160.0000.022	2 Ad. IP44 5x16A CEE Ön + 2 Ad. 1x16A Yan	1	596,00 TL
42100.5320.0000.012	1 Ad. IP44 5x32A CEE Ön + 2 Ad. 1x16A Ön	1	530,00 TL
42100.5320.0000.022	2 Ad. IP44 5x32A CEE Ön + 2 Ad. 1x16A Yan	1	717,00 TL
42100.5321.0000.014	1 Ad. IP67 5x32A CEE Ön + 2 Ad. 1x16A Ön + 2 Ad. 1x16A Yan	1	642,00 TL
42100.3163.0000.022	2 Ad. IP44 3x16A Ön + 2 Ad. 1x16A Yan	1	513,00 TL
42100.3323.3163.112	1 Ad. IP44 3x32A Ön + 1 Ad. IP44 3x16A Ön + 2 Ad. 1x16A Yan	1	535,00 TL
42100.3323.0000.022	2 Ad. IP44 3x32A CEE Ön + 2 Ad. 1x16A Yan	1	557,00 TL

Ürün Kodu	IP67 Kombinasyon Kutuları		Fiyat
62100	210x280x100mm IP67 Boş Kombinasyon Kutusu	1	285,00 TL
62100.4160.0000.011	1 Ad. IP44 4x16A CEE Ön + 1 Ad. 1x16A Ön	1	436,00 TL
62100.4160.0000.012	1 Ad. IP44 4x16A CEE Ön + 2 Ad. 1x16A Ön	1	481,00 TL
62100.4160.0000.022	2 Ad. IP44 4x16A CEE Ön + 2 Ad. 1x16A Yan	1	601,00 TL
62100.4250.0000.021	2 Ad. IP44 4x25A Ön + 1 Ad. 1x16A Yan	1	458,00 TL
62100.4250.0000.022	2 Ad. IP44 4x25A Ön + 2 Ad. 1x16A Yan	1	503,00 TL
62100.0000.4320.022	2 Ad. IP44 4x32A CEE Ön + 2 Ad. 1x16A Yan	1	679,00 TL
62100.4321.0000.024	2 Ad. IP67 4x32A CEE Ön + 4 Ad. 1x16A Yan	1	824,00 TL
62100.5160.0000.022	2 Ad. IP44 5x16A CEE Ön + 2 Ad. 1x16A Yan	1	613,00 TL
62100.5320.0000.012	1 Ad. IP44 5x32A CEE Ön + 2 Ad. 1x16A Ön	1	547,00 TL
62100.5320.0000.022	2 Ad. IP44 5x32A CEE Ön + 2 Ad. 1x16A Yan	1	734,00 TL
62100.5321.0000.014	1 Ad. IP67 5x32A CEE Ön + 2 Ad. 1x16A Ön + 2 Ad. 1x16A Yan	1	659,00 TL
62100.3163.0000.022	2 Ad. IP44 3x16A Ön + 2 Ad. 1x16A Yan	1	529,00 TL
62100.3323.3163.112	1 Ad. IP44 3x32A Ön + 1 Ad. IP44 3x16A Ön + 2 Ad. 1x16A Yan	1	551,00 TL
62100.3323.0000.022	2 Ad. IP44 3x32A CEE Ön + 2 Ad. 1x16A Yan	1	573,00 TL



62100



62100.3163.0000.022



62100.4160.0000.012



62100.4320.0000.022



62100.5321.0000.020

**210x280mm Priz Montajlı Sigortalı Kombinasyon Kutuları
(8 Sigorta Kapasiteli - Halojen Free)**

Ürün Kodu	IP44 Kombinasyon Kutuları		Fiyat
42080	210x280x100mm IP44 Boş Kombinasyon Kutusu	1	230,00 TL
42080.4160.0000.011	1 Ad. IP44 4x16A CEE Ön + 1 Ad. 1x16A Ön	1	381,00 TL
42080.4160.0000.012	1 Ad. IP44 4x16A CEE Ön + 2 Ad. 1x16A Ön	1	422,00 TL
42080.4160.0000.022	2 Ad. IP44 4x16A CEE Ön + 2 Ad. 1x16A Yan	1	532,00 TL
42080.4250.0000.021	2 Ad. IP44 4x25A Ön + 1 Ad. 1x16A Yan	1	401,00 TL
42080.4250.0000.022	2 Ad. IP44 4x25A Ön + 2 Ad. 1x16A Yan	1	442,00 TL
42080.4320.0000.022	2 Ad. IP44 4x32A CEE Ön + 2 Ad. 1x16A Yan	1	602,00 TL
42080.4321.0000.024	2 Ad. IP67 4x32A CEE Ön + 4 Ad. 1x16A Yan	1	734,00 TL
42080.5160.0000.022	2 Ad. IP44 5x16A CEE Ön + 2 Ad. 1x16A Yan	1	542,00 TL
42080.5320.0000.012	1 Ad. IP44 5x32A CEE Ön + 2 Ad. 1x16A Ön	1	482,00 TL
42080.5320.0000.022	2 Ad. IP44 5x32A CEE Ön + 2 Ad. 1x16A Yan	1	652,00 TL
42080.5321.0000.014	1 Ad. IP67 5x32A CEE Ön + 2 Ad. 1x16A Ön + 2 Ad. 1x16A Yan	1	584,00 TL
42080.3163.0000.022	2 Ad. IP44 3x16A Ön + 2 Ad. 1x16A Yan	1	466,00 TL
42080.3323.3163.112	1 Ad. IP44 3x32A Ön + 1 Ad. IP44 3x16A Ön + 2 Ad. 1x16A Yan	1	486,00 TL
42080.3323.0000.022	2 Ad. IP44 3x32A CEE Ön + 2 Ad. 1x16A Yan	1	506,00 TL

Ürün Kodu	IP67 Kombinasyon Kutuları		Fiyat
62080	210x280x100mm IP67 Boş Kombinasyon Kutusu	1	245,00 TL
62080.4160.0000.011	1 Ad. IP44 4x16A CEE Ön + 1 Ad. 1x16A Ön	1	396,00 TL
62080.4160.0000.012	1 Ad. IP44 4x16A CEE Ön + 2 Ad. 1x16A Ön	1	437,00 TL
62080.4160.0000.022	2 Ad. IP44 4x16A CEE Ön + 2 Ad. 1x16A Yan	1	547,00 TL
62080.4250.0000.021	2 Ad. IP44 4x25A Ön + 1 Ad. 1x16A Yan	1	416,00 TL
62080.4250.0000.022	2 Ad. IP44 4x25A Ön + 2 Ad. 1x16A Yan	1	457,00 TL
62080.4320.0000.022	2 Ad. IP44 4x32A CEE Ön + 2 Ad. 1x16A Yan	1	617,00 TL
62080.4321.0000.024	2 Ad. IP67 4x32A CEE Ön + 4 Ad. 1x16A Yan	1	749,00 TL
62080.5160.0000.022	2 Ad. IP44 5x16A CEE Ön + 2 Ad. 1x16A Yan	1	557,00 TL
62080.5320.0000.012	1 Ad. IP44 5x32A CEE Ön + 2 Ad. 1x16A Ön	1	497,00 TL
62080.5320.0000.022	2 Ad. IP44 5x32A CEE Ön + 2 Ad. 1x16A Yan	1	667,00 TL
62080.5321.0000.014	1 Ad. IP67 5x32A CEE Ön + 2 Ad. 1x16A Ön + 2 Ad. 1x16A Yan	1	599,00 TL
62080.3163.0000.022	2 Ad. IP44 3x16A Ön + 2 Ad. 1x16A Yan	1	481,00 TL
62080.3323.3163.112	1 Ad. IP44 3x32A Ön + 1 Ad. IP44 3x16A Ön + 2 Ad. 1x16A Yan	1	501,00 TL
62080.3323.0000.022	2 Ad. IP44 3x32A CEE Ön + 2 Ad. 1x16A Yan	1	521,00 TL



62080



62080.3160.62080.022



62080.4160.0000.012



62080.4320.0000.022



452.5321.0000.020

HALOJEN FREE

**135x250mm Priz Montajlı Sigortalı Kombinasyon Kutuları
(6 Sigorta Kapasiteli - Halojen Free)**

Ürün Kodu	IP44 Kombinasyon Kutuları		Fiyat
41060	135x250x120mm IP44 Boş Kombinasyon Kutusu	2	195,00 TL
41060.3163.0000.012	1 Ad. IP44 3x16A Ön + 2 Ad. 1x16A Yan	2	354,00 TL
41060.3323.0000.012	1 Ad. IP44 3x32A Ön + 2 Ad. 1x16A Yan	2	374,00 TL
41060.4250.0000.012	1 Ad. IP44 4x25A Ön + 2 Ad. 1x16A Yan	2	342,00 TL
41060.4160.0000.012	1 Ad. IP44 4x16A CEE Ön + 2 Ad. 1x16A Yan	2	387,00 TL
41060.4320.0000.012	1 Ad. IP44 4x32A CEE Ön + 2 Ad. 1x16A Yan	2	422,00 TL
41060.5160.0000.012	1 Ad. IP44 5x16A CEE Ön + 2 Ad. 1x16A Yan	2	392,00 TL
41060.5320.0000.012	1 Ad. IP44 5x32A CEE Ön + 2 Ad. 1x16A Yan	2	447,00 TL



41060

Ürün Kodu	IP67 Kombinasyon Kutuları		Fiyat
61060	135x250x120mm IP67 Boş Kombinasyon Kutusu	2	200,00 TL
61060.3163.0000.012	1 Ad. IP44 3x16A Ön + 2 Ad. 1x16A Yan	2	359,00 TL
61060.3323.0000.012	1 Ad. IP44 3x32A Ön + 2 Ad. 1x16A Yan	2	379,00 TL
61060.4250.0000.012	1 Ad. IP44 4x25A Ön + 2 Ad. 1x16A Yan	2	347,00 TL
61060.4160.0000.012	1 Ad. IP44 4x16A CEE Ön + 2 Ad. 1x16A Yan	2	392,00 TL
61060.4320.0000.012	1 Ad. IP44 4x32A CEE Ön + 2 Ad. 1x16A Yan	2	427,00 TL
61060.5160.0000.012	1 Ad. IP44 5x16A CEE Ön + 2 Ad. 1x16A Yan	2	397,00 TL
61060.5320.0000.012	1 Ad. IP44 5x32A CEE Ön + 2 Ad. 1x16A Yan	2	452,00 TL



61060

**113x210mm Priz Montajlı Sigortalı Kombinasyon Kutuları
(4 Sigorta Kapasiteli - Halojen Free)**

HALOJEN FREE

Ürün Kodu	IP44 Kombinasyon Kutuları		Fiyat
41040	113x210x90mm IP44 Boş Kombinasyon Kutusu	3	140,00 TL
41040.3163.0000.012	1 Ad. IP44 3x16A Ön + 2 Ad. 1x16A Yan	3	299,00 TL
41040.3323.0000.012	1 Ad. IP44 3x32A Ön + 2 Ad. 1x16A Yan	3	319,00 TL
41040.4250.0000.012	1 Ad. IP44 4x25A Ön + 2 Ad. 1x16A Yan	3	287,00 TL
41040.4160.0000.012	1 Ad. 1P44 4x16A CEE Ön + 2 Ad. 1x16A Yan	3	332,00 TL
41040.4320.0000.012	1 Ad. 1P44 4x32A CEE Ön + 2 Ad. 1x16A Yan	3	367,00 TL
41040.5160.0000.012	1 Ad. 1P44 5x16A CEE Ön + 2 Ad. 1x16A Yan	3	337,00 TL
41040.5320.0000.012	1 Ad. 1P44 5x32A CEE Ön + 2 Ad. 1x16A Yan	3	392,00 TL



41040

Ürün Kodu	IP67 Kombinasyon Kutuları		Fiyat
61040	113x210x90mm IP67 Boş Kombinasyon Kutusu	3	150,00 TL
61040.3163.0000.012	1 Ad. IP44 3x16A Ön + 2 Ad. 1x16A Yan	3	309,00 TL
61040.3323.0000.012	1 Ad. IP44 3x32A Ön + 2 Ad. 1x16A Yan	3	329,00 TL
61040.4250.0000.012	1 Ad. IP44 4x25A Ön + 2 Ad. 1x16A Yan	3	297,00 TL
61040.4160.0000.012	1 Ad. 1P44 4x16A CEE Ön + 2 Ad. 1x16A Yan	3	342,00 TL
61040.4320.0000.012	1 Ad. 1P44 4x32A CEE Ön + 2 Ad. 1x16A Yan	3	377,00 TL
61040.5160.0000.012	1 Ad. 1P44 5x16A CEE Ön + 2 Ad. 1x16A Yan	3	347,00 TL
61040.5320.0000.012	1 Ad. 1P44 5x32A CEE Ön + 2 Ad. 1x16A Yan	3	402,00 TL



61040

**113x210mm Priz Montajlı Sigortalı Kombinasyon Kutuları
(4 Sigorta Kapasiteli - Halojen Free)**

HALOJEN FREE

Ürün Kodu	IP44 Kombinasyon Kutuları		Fiyat
3540	113x210x90mm IP44 Boş Kombinasyon Kutusu	3	105,00 TL
3540.3320.012	1 Ad. IP44 3x32A CEE Ön + 2 Ad. 1x16A Yan	3	297,00 TL
3540.4160.012	1 Ad. IP44 4x16A CEE Ön + 2 Ad. IP44 1x16A Yan	3	297,00 TL
3540.3163.012	1 Ad. IP44 3x16A Ön + 2 Ad. 1x16A Yan	3	264,00 TL
3540.3323.012	1 Ad. IP44 3x32A Ön + 2 Ad. 1x16A Yan	3	284,00 TL



3540



3540.3320.012



3540.4160.012



3540.3163.012



3540.3323.012

**Priz Montajlı Sigortasız Kombinasyon Kutuları
(Halojen Free)**

HALOJEN FREE

Ürün Kodu	IP44 Kombinasyon Kutuları		Fiyat
44000	210x280x100mm IP44 Boş Kombinasyon Kutusu	1	195,00 TL
44000.4320.4160.224	2 Ad. IP44 4x32A CEE Ön + 2 Ad. IP44 4x16A CEE Ön + 4 Ad. 1x16A Yan	1	869,00 TL
44000.4320.5160.220	2 Ad. IP44 4x32A CEE Ön + 2 Ad. IP44 5x16A CEE Ön	1	715,00 TL
41000	113x113x73mm IP44 Boş Kombinasyon Kutusu	6	48,00 TL
41000.4160.0000.012	1 Ad. IP44 4x16A CEE Ön + 2 Ad. 1x16A Yan	6	240,00 TL
41000.5160.0000.012	1 Ad. IP44 5x16A CEE Ön + 2 Ad. 1x16A Yan	6	245,00 TL
42000	210x113x73mm IP44 Boş Kombinasyon Kutusu	3	74,00 TL
42000.4320.0000.022	2 Ad. IP44 4x32A CEE Ön + 2 Ad. 1x16A Yan	3	446,00 TL
42000.5320.0000.022	2 Ad. IP44 5x32A CEE Ön + 2 Ad. 1x16A Yan	3	496,00 TL

Ürün Kodu	IP67 Kombinasyon Kutuları		Fiyat
-----------	---------------------------	---	-------

64000	210x280x100mm IP67 Boş Kombinasyon Kutusu	1	205,00 TL
64000.4321.4161.224	2 Ad. IP67 4x32A CEE Ön + 2 Ad. IP67 4x16A CEE Ön + 4 Ad. 1x16A Yan	1	1.009,00 TL
64000.4320.5160.220	2 Ad. IP44 4x32A CEE Ön + 2 Ad. IP44 5x16A CEE Ön	1	725,00 TL
61000	113x113x73mm IP67 Boş Kombinasyon Kutusu	6	57,00 TL
61000.4160.0000.012	1 Ad. IP44 4x16A CEE Ön + 2 Ad. 1x16A Yan	6	249,00 TL
61000.5160.0000.012	1 Ad. IP44 5x16A CEE Ön + 2 Ad. 1x16A Yan	6	197,00 TL
62000	210x113x73mm IP67 Boş Kombinasyon Kutusu	3	90,00 TL
62000.4320.0000.022	2 Ad. IP44 4x32A CEE Ön + 2 Ad. 1x16A Yan	3	372,00 TL
62000.5320.0000.022	2 Ad. IP44 5x32A CEE Ön + 2 Ad. 1x16A Yan	3	422,00 TL



64000



64000.4160.0000.028



64000.4160.4320.224



62000.5320.0000.022



61000.4160.0000.012

Küçük Boy Taşıyıcı Ayak

Ürün Kodu	Açıklama	Ölçü (mm)		Fiyat
740.022.001	(351 - 451 - 352 - 452 - 361) Kombinasyonlar + (21x30 - 26x35 30x40) Panolar	310x610	1	320,00 TL

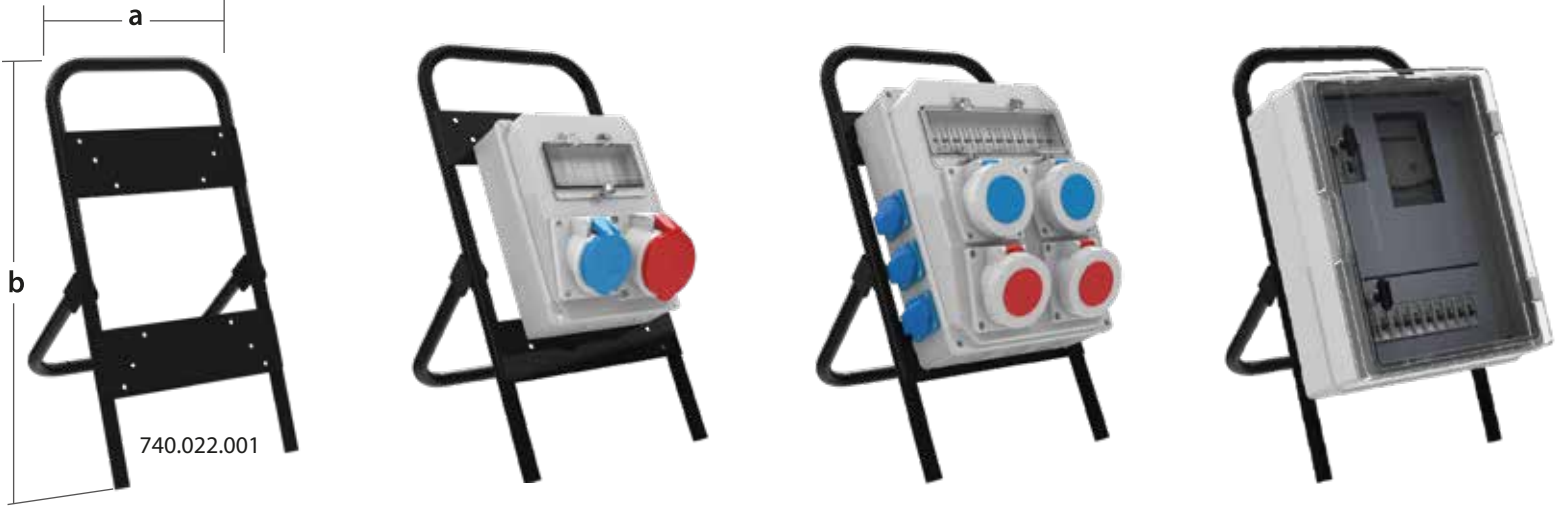

Büyük Boy Taşıyıcı Ayak

Ürün Kodu	Açıklama	Ölçü (mm)		Fiyat
740.022.002	(40x50 - 40x60 - 50x70) Panolar	510x1010	1	490,00 TL



Opak Kapaklı Termoplastik Buatlar

HALOJEN FREE

IP44 Ürün Kodu	IP67 Ürün Kodu	Dış Ölçü(mm)		IP44 Fiyat	IP67 Fiyat
344.041.101	-	85 x 85 x 41	24	26,00 TL	-
344.055.201	367.055.201	95 x 95 x 55	12	35,00 TL	39,00 TL
344.073.301	367.073.301	113 x 113 x 73	12	54,00 TL	68,00 TL
344.120.301	367.120.301	113 x 113 x 120	6	60,00 TL	75,00 TL
344.073.401	367.073.401	113 x 210 x 73	6	85,00 TL	103,00 TL
344.120.401	367.120.401	113 x 210 x 120	3	110,00 TL	129,00 TL
344.085.421	367.085.421	130 x 245 x 85	2	126,00 TL	145,00 TL
344.140.421	367.140.421	130 x 245 x 140	2	144,00 TL	178,00 TL
344.100.501	367.100.501	210 x 280 x 100	1	200,00 TL	234,00 TL
344.135.601	367.135.601	210 x 280 x 135	1	218,00 TL	242,00 TL
344.115.501	367.115.501	260 x 350 x 115	1	336,00 TL	367,00 TL
344.145.601	367.145.601	260 x 350 x 145	1	362,00 TL	394,00 TL
344.155.601	367.155.601	260 x 350 x 155	1	371,00 TL	403,00 TL
344.185.601	367.185.601	260 x 350 x 185	1	398,00 TL	435,00 TL



367.073.301



367.073.401



367.100.501



367.135.601



367.155.601

Şeffaf Kapaklı Termoplastik Buatlar

HALOJEN FREE

IP44 Ürün Kodu	IP67 Ürün Kodu	Dış Ölçü(mm)		IP44 Fiyat	IP67 Fiyat
344.055.202	367.055.202	95 x 95 x 55	12	40,00 TL	44,00 TL
344.073.302	367.073.302	113 x 113 x 73	12	60,00 TL	72,00 TL
344.120.302	367.120.302	113 x 113 x 120	6	76,00 TL	88,00 TL
344.073.402	367.073.402	113 x 210 x 73	6	92,00 TL	110,00 TL
344.120.402	367.120.402	113 x 210 x 120	3	130,00 TL	150,00 TL
344.085.422	367.085.422	130 x 245 x 85	2	142,00 TL	160,00 TL
344.140.422	367.140.422	130 x 245 x 140	2	160,00 TL	180,00 TL
344.100.502	367.100.502	210 x 280 x 100	1	234,00 TL	260,00 TL
344.135.602	367.135.602	210 x 280 x 135	1	250,00 TL	275,00 TL
344.115.502	367.115.502	260 x 350 x 115	1	394,00 TL	413,00 TL
344.145.602	367.145.602	260 x 350 x 145	1	420,00 TL	440,00 TL
344.155.602	367.155.602	260 x 350 x 155	1	422,00 TL	442,00 TL
344.185.602	367.185.602	260 x 350 x 185	1	448,00 TL	472,00 TL



367.073.302



367.073.402



367.100.502



367.135.602



367.155.602

Taban Saclı

IP65

HALOJEN FREE

Ürün Kodu		Ölçü(cm)		Fiyat	
Opak Kapak	Şeffaf Kapak			Opak Kapak	Şeffaf Kapak
910.2130.131.000	910.2130.132.000	21 x 30 x 13	20	352,00 TL	400,00 TL
910.2635.151.000	910.2635.152.000	26 x 35 x 15	12	475,00 TL	542,00 TL
910.2635.181.000	910.2635.182.000	26 x 35 x 18	12	498,00 TL	565,00 TL
910.3040.131.000	910.3040.132.000	30 x 40 x 13	10	585,00 TL	695,00 TL
910.3040.171.000	910.3040.172.000	30 x 40 x 17	8	600,00 TL	722,00 TL
910.3040.191.000	910.3040.192.000	30 x 40 x 19	8	680,00 TL	800,00 TL
910.3040.231.000	910.3040.232.000	30 x 40 x 23	8	700,00 TL	810,00 TL
910.4050.201.000	910.4050.202.000	40 x 50 x 20	6	1.080,00 TL	1.200,00 TL
910.4060.201.000	910.4060.202.000	40 x 60 x 20	6	1.165,00 TL	1.485,00 TL
910.5070.251.000	910.5070.252.000	50 x 70 x 25	4	1.820,00 TL	2.190,00 TL



910.2130.132.000



910.2635.151.000



910.3040.232.000



910.4050.201.000

Perdeli

IP65

HALOJEN FREE

Ürün Kodu		Ölçü(cm)	Açıklama		Fiyat	
Opak Kapak	Şeffaf Kapak				Opak Kapak	Şeffaf Kapak
920.2130.131.016	920.2130.132.016	21 x 30 x 13	2 x 8 Sigorta	20	635,00 TL	679,00 TL
920.2635.151.018	920.2635.152.018	26 x 35 x 15	2 x 9 Sigorta	12	744,00 TL	810,00 TL
920.3040.131.024	920.3040.132.024	30 x 40 x 13	3 x 8 Sigorta	10	890,00 TL	985,00 TL
920.3040.171.024	920.3040.172.024	30 x 40 x 17	3 x 8 Sigorta	8	915,00 TL	1.014,00 TL
920.4050.201.048	920.4050.202.048	40 x 50 x 20	3 x 16 Sigorta	6	1.560,00 TL	1.700,00 TL
920.4060.201.064	920.4060.202.064	40 x 60 x 20	4 x 16 Sigorta	6	1.800,00 TL	2.120,00 TL
920.5070.251.100	920.5070.252.100	50 x 70 x 25	5 x 20 Sigorta	4	2.580,00 TL	2.950,00 TL



920.2635.151.018



920.3040.172.024



920.4050.201.048



920.4060.202.064

Perdeli + Kompakt Şalterli

IP65

HALOJEN FREE

Ürün Kodu		Ölçü(cm)	Açıklama		Fiyat	
Opak Kapak	Şeffaf Kapak				Opak Kapak	Şeffaf Kapak
922.4050.201.032	922.4050.202.032	40 x 50 x 20	2 x 16 Sigorta + 1 Kompakt Şalter	6	1.560,00 TL	1.700,00 TL
922.4060.201.048	922.4060.202.048	40x 60 x 20	3 x 16 Sigorta + 1 Kompakt Şalter	6	1.800,00 TL	2.120,00 TL
922.5070.251.080	922.5070.252.080	50 x 70 x 25	4 x 20 Sigorta + 1 Kompakt Şalter	4	2.580,00 TL	2.950,00 TL



922.4050.202.032



922.4060.201.048



922.5070.252.080

Monofaze Sayaçlı

IP65

HALOJEN FREE

Ürün Kodu		Ölçü(cm)	Açıklama		Fiyat	
Opak Kapak	Şeffaf Kapak				Opak Kapak	Şeffaf Kapak
930.2130.131.003	930.2130.132.003	21 x 30 x 13	1 Sayaç + 3 Sigorta	20	635,00 TL	679,00 TL
930.2635.151.003	930.2635.152.003	26x 35 x 15	1 Sayaç + 3 Sigorta	12	744,00 TL	810,00 TL

Monofaze Sayaç+ Dağıtımlı

IP65

HALOJEN FREE

Ürün Kodu		Ölçü(cm)	Açıklama		Fiyat	
Opak Kapak	Şeffaf Kapak				Opak Kapak	Şeffaf Kapak
931.3040.131.013	931.3040.132.013	30 x 40 x 13	1 Sayaç + 13 Sigorta	10	890,00 TL	985,00 TL
931.3040.171.013	931.3040.172.013	30 x 40 x 17	1 Sayaç + 13 Sigorta	8	915,00 TL	1.014,00 TL
931.4050.201.224	931.4050.202.224	40 x 50 x 20	2 Sayaç + 24 Sigorta	6	1.560,00 TL	1.700,00 TL



930.2635.151.003



931.4050.202.224

Trifaze Sayaçlı

IP65

HALOJEN FREE

Ürün Kodu		Ölçü(cm)	Açıklama	📦	Fiyat	
Opak Kapak	Şeffaf Kapak				Opak Kapak	Şeffaf Kapak
935.3040.131.010	935.3040.132.010	30 x 40 x 13	1 Sayaç + 10 Sigorta	10	890,00 TL	985,00 TL
935.3040.171.010	935.3040.172.010	30 x 40 x 17	1 Sayaç + 10 Sigorta	8	915,00 TL	1.014,00 TL
935.4050.201.008	935.4050.202.008	40 x 50 x 20	1 Sayaç + 8 Sigorta	6	1.560,00 TL	1.700,00 TL
935.4060.201.008	935.4060.202.008	40 x 60 x 20	1 Sayaç + 8 Sigorta	6	1.800,00 TL	2.120,00 TL
935.5070.251.010	935.5070.252.010	50 x 70 x 25	1 Sayaç + 10 Sigorta	4	2.580,00 TL	2.950,00 TL
942.5070.251.000	942.5070.252.000	50 x 70 x 25	Kompakt Şalter + Kaçak Akım + Akım Trafo	4	2.580,00 TL	2.950,00 TL



936.4050.202.008



935.4060.201.008



935.5070.252.010



942.5070.251.000

Trifaze Sayaç + Dağıtım

IP65

HALOJEN FREE

Ürün Kodu		Ölçü(cm)	Açıklama	📦	Fiyat	
Opak Kapak	Şeffaf Kapak				Opak Kapak	Şeffaf Kapak
936.4050.201.024	936.4050.202.024	40 x 50 x 20	1 Sayaç + 24 Sigorta	6	1.560,00 TL	1.700,00 TL
936.4060.201.040	936.4060.202.040	40 x 60 x 20	1 Sayaç + 40 Sigorta	6	1.800,00 TL	2.120,00 TL
936.5070.251.068	936.5070.252.068	50 x 70 x 25	1 Sayaç + 68 Sigorta	4	2.580,00 TL	2.950,00 TL



936.4050.202.024



936.4060.201.040



936.4050.252.068

Şantiye Panoları

IP65

HALOJEN FREE

Ürün Kodu		Ölçü(cm)	Açıklama		Fiyat	
Opak Kapak	Şeffaf Kapak				Opak Kapak	Şeffaf Kapak
965.4060.201.024	965.4060.202.024	40 x 60 x 20	1 Trifaze Sayaç + 24 Sigorta + 3 Priz Yeri	6	1.800,00 TL	2.120,00 TL
965.5070.251.048	965.5070.252.048	50 x 70 x 25	1 Trifaze Sayaç + 48 Sigorta + 4 Priz Yeri	4	2.580,00 TL	2.950,00 TL
965.5070.251.028	965.5070.252.028	50 x 70 x 25	1 Trifaze Sayaç + 28 Sigorta + 8 Priz Yeri	4	2.580,00 TL	2.950,00 TL
966.4050.201.032	966.4050.202.032	40 x 50 x 20	32 Sigorta + 3 Priz Yeri	6	1.560,00 TL	1.700,00 TL
966.4060.201.048	966.4060.202.048	40 x 60 x 20	48 Sigorta + 3 Priz Yeri	6	1.800,00 TL	2.120,00 TL
966.4060.201.032	966.4060.202.032	40 x 60 x 20	32 Sigorta + 6 Priz Yeri	6	1.800,00 TL	2.120,00 TL
966.5070.251.060	966.5070.252.060	50 x 70 x 25	60 Sigorta + 8 Priz Yeri	4	2.580,00 TL	2.950,00 TL



966.4050.202.032



966.4060.201.032



965.4060.202.024



965.5070.251.028

Kofra Panoları

IP65

HALOJEN FREE

Ürün Kodu		Ölçü(cm)		Fiyat	
Opak Kapak	Şeffaf Kapak			Opak Kapak	Şeffaf Kapak
923.2635.151.000	923.2635.152.000	26 x 35 x 15	12	585,00 TL	636,00 TL
923.3040.171.000	923.3040.172.000	30 x 40 x 17	8	714,00 TL	791,00 TL
923.4050.201.000	923.4050.202.000	40 x 50 x 20	6	1.217,00 TL	1326,00 TL



923.2635.151.000



923.3040.171.000



923.4050.202.000

Harici Telefon Dağıtım
Opak Kapaklı

IP65

HALOJEN FREE

Ürün Kodu	Ölçü(cm)	Açıklama		Fiyat		
				XXX (950) Boş	XXX (951) Çatılı	XXX (952) Çatılı + Regletli
XXX.2130.131.030	21 x 30 x 13	Çatı + Regletli 30 Per	20	313,00 TL	388,00 TL	673,00 TL
XXX.2635.151.050	26 x 35 x 15	Çatı + Regletli 50 Per	12	417,00 TL	542,00 TL	1.017,00 TL
XXX.3040.131.100	30 x 40 x 13	Çatı + Regletli 100 Per	10	525,00 TL	775,00 TL	1.725,00 TL
XXX.3040.171.100	30 x 40 x 17	Çatı + Regletli 100 Per	8	546,00 TL	796,00 TL	1.746,00 TL
XXX.4050.201.150	40 x 50 x 20	Çatı + Regletli 150 Per	6	965,00 TL	1.340,00 TL	2.765,00 TL
XXX.4050.201.200	40 x 50 x 20	Çatı + Regletli 200 Per	6	965,00 TL	1.465,00 TL	3.365,00 TL
XXX.4050.201.300	40 x 50 x 20	Çatı + Regletli 300 Per	6	965,00 TL	1.715,00 TL	4.565,00 TL
XXX.4060.201.400	40 x 60 x 20	Çatı + Regletli 400 Per	6	990,00 TL	1.990,00 TL	5.790,00 TL
XXX.5070.251.500	50 x 70 x 25	Çatı + Regletli 500 Per	4	1.560,00 TL	2.810,00 TL	7.560,00 TL

Harici Telefon Dağıtım
Şeffaf Kapaklı

IP65

HALOJEN FREE

Ürün Kodu	Ölçü(cm)	Açıklama		Fiyat		
				XXX (950) Boş	XXX (951) Çatılı	XXX (952) Çatılı + Regletli
XXX.2130.132.030	21 x 30 x 13	Çatı + Regletli 30 Per	20	361,00 TL	436,00 TL	721,00 TL
XXX.2635.152.050	26 x 35 x 15	Çatı + Regletli 50 Per	12	484,00 TL	609,00 TL	1.084,00 TL
XXX.3040.132.100	30 x 40 x 13	Çatı + Regletli 100 Per	10	625,00 TL	875,00 TL	1.825,00 TL
XXX.3040.172.100	30 x 40 x 17	Çatı + Regletli 100 Per	8	654,00 TL	904,00 TL	1.854,00 TL
XXX.4050.202.150	40 x 50 x 20	Çatı + Regletli 150 Per	6	1.150,00 TL	1.525,00 TL	2.950,00 TL
XXX.4050.202.200	40 x 50 x 20	Çatı + Regletli 200 Per	6	1.150,00 TL	1.650,00 TL	3.550,00 TL
XXX.4050.202.300	40 x 50 x 20	Çatı + Regletli 300 Per	6	1.150,00 TL	1.900,00 TL	4.750,00 TL
XXX.4060.202.400	40 x 60 x 20	Çatı + Regletli 400 Per	6	1.310,00 TL	2.310,00 TL	6.110,00 TL
XXX.5070.252.500	50 x 70 x 25	Çatı + Regletli 500 Per	4	1.930,00 TL	3.180,00 TL	7.930,00 TL



952.2635.152.050



952.3040.131.100



952.4050.202.200



952.5070.251.500

Sulama Panoları

IP65

HALOJEN FREE

Ürün Kodu		Ölçü(cm)	Açıklama		Fiyat	
Opak Kapak	Şeffaf Kapak				Opak Kapak	Şeffaf Kapak
960.4050.201.000	960.4050.202.000	40 x 50 x 20	Voltmetre + Ampermetre + Sinyal	6	1.560,00 TL	1.700,00 TL
960.4060.201.000	960.4060.202.000	40x 60 x 20	Voltmetre + Ampermetre + Sinyal	6	1.800,00 TL	2.120,00 TL
960.5070.251.000	960.5070.252.000	50 x 70 x 25	Voltmetre + Ampermetre + Sinyal	4	2.580,00 TL	2.950,00 TL



960.4050.202.000



960.4060.201.000



960.5070.252.000

Pano Aksesuarları

Ürün Kodu	Açıklama		Fiyat
740.020.000	(40 x 50 - 40 x 60 - 50 x 70) Pano Ayak	1	190,00 TL
740.030.026	26 x 35 Pano Çatı	1	75,00 TL
740.030.030	30 x 40 Pano Çatı	1	98,00 TL
740.030.045	(40 x 50 - 40 x 60) Pano Çatı	1	105,00 TL
740.030.050	50 x 70 Pano Çatı	1	140,00 TL
740.010.001	Reglet - Kesmeli	100	110,40 TL
740.011.000	Çatı - Tekli	100	30,00 TL



740.011.000



740.010.001

**M150 Plastik Gövdeli
Kablosuz Makaralar**



Ürün Kodu

Açıklama



Fiyat

150.000.04

4(1x16A) Şebeke

10

450,00 TL

150.000.04.T

4(1x16A) Şebeke + Termikli

10

485,00 TL

**M100 Metal Gövdeli Kablosuz
Makaralar - Sinyal Ledli**

Ürün Kodu

Açıklama



Fiyat



100.000.004

4(1x16A) Şebeke

10

623,00 TL

100.000.004.T

4(1x16A) Şebeke + Termikli



10





660,00 TL

Makara Cinsi	Kablo Kesiti	3x1,5 TTR	3x2,5 TTR	3x4 TTR	4x1,5 TTR	4x2,5 TTR	4x4 TTR	5x1,5 TTR	5x2,5 TTR	5x4 TTR
M100		50	40	30	-	-	-	-	-	-
M120		100	75	60	80	65	45	75	50	40
M150		60	50	40	-	-	-	-	-	-

M120 Kablosuz Makaralar

M120 Metal Gövdeli

Ürün Kodu	12X.000.004	12X.000.004.T	12X.000.004E	12X.316.012	12X.416.012
Makara Göbekleri					
Açıklama	4(1x16A) Şebeke + Sinyal	4(1x16A) Şebeke + Sinyal + Termikli	4(1x16A) Pano Prizi + Sinyal	1(3x16A) CEE + 2(1x16A) Pano Prizi	1(4x16A) CEE + 2(1x16A) Pano Prizi
Makara Fiyat	760,00 TL	795,00 TL	824,00 TL	837,00 TL	852,00 TL
Tekerlekli Makara Fiyat	950,00 TL	964,00 TL	994,00 TL	1.007,00 TL	1.022,00 TL
Arabalı Makara Fiyat	1.133,00 TL	1.167,00 TL	1.197,00 TL	1.210,00 TL	1.225,00 TL

Ürün Kodu	12X.516.012	12X.425.012	12X.332.012	12X.432.012	12X.532.012
Makara Göbekleri					
Açıklama	1(5x16A) CEE + 2(1x16A) Pano Prizi	1(4x25A) CEE + 2(1x16A) Pano Prizi	1(3x32A) CEE + 2(1x16A) Pano Prizi	1(4x32A) CEE + 2(1x16A) Pano Prizi	1(5x32A) CEE + 2(1x16A) Pano Prizi
Makara Fiyat	857,00 TL	807,00 TL	872,00 TL	887,00 TL	912,00 TL
Tekerlekli Makara Fiyat	1.027,00 TL	977,00 TL	1.042,00 TL	1.057,00 TL	1.082,00 TL
Arabalı Makara Fiyat	1.230,00 TL	1.180,00 TL	1.245,00 TL	1.260,00 TL	1.285,00 TL

Makara Cinsi	Kablo Kesiti	3x1,5 TTR	3x2,5 TTR	3x4 TTR	4x1,5 TTR	4x2,5 TTR	4x4 TTR	5x1,5 TTR	5x2,5 TTR	5x4 TTR
M120		100	75	60	80	65	45	75	50	40

X = 0 Borulu Makara X = 1 Arabalı Makara X = 2 Tekerlekli Makara



120.000.004.T







122.416.012



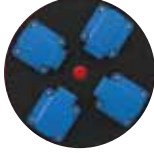

121.425.012

M130 Kablosuz Makaralar

M130 Metal Gövdeli

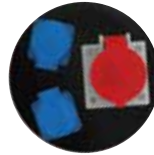
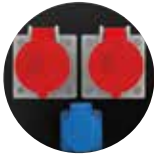
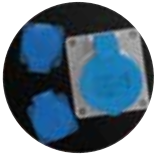
Ürün Kodu	13X.000.004	13X.416.012	13X.416.021	13X.516.012	13X.516.021
Makara Göbekleri					
Açıklama	4(1x16A) Pano Prizi + Sinyal	1(4x16A) CEE + 2(1x16A) Pano Prizi	2(4x16A) CEE + 1(1x16A) Pano Prizi	1(5x16A) CEE + 2(1x16A) Pano Prizi	2(5x16A) CEE + 1(1x16A) Pano Prizi
Makara Fiyat	975,00 TL	1.000,00 TL	1.070,00 TL	1.015,00 TL	1.100,00 TL
Tekerlekli Makara Fiyat	1.029,00 TL	1.057,00 TL	1.126,00 TL	1.062,00 TL	1.136,00 TL
Arabalı Makara Fiyat	1.232,00 TL	1.260,00 TL	1.329,00 TL	1.265,00 TL	1.339,00 TL

Ürün Kodu	13X.425.012	13X.425.021	13X.332.012	13X.432.012	13X.532.012
Makara Göbekleri					
Açıklama	1(4x25A) CEE + 2(1x16A) Pano Prizi	2(4x25A) CEE + 1(1x16A) Pano Prizi	1(3x32A) CEE + 2(1x16A) Pano Prizi	1(4x32A) CEE + 2(1x16A) Pano Prizi	1(5x32A) CEE + 2(1x16A) Pano Prizi
Makara Fiyat	860,00 TL	980,00 TL	1.030,00 TL	1.060,00 TL	1.080,00 TL
Tekerlekli Makara Fiyat	1.012,00 TL	1.036,00 TL	1.077,00 TL	1.092,00 TL	1.117,00 TL
Arabalı Makara Fiyat	1.215,00 TL	1.239,00 TL	1.280,00 TL	1.295,00 TL	1.320,00 TL

Makara Cinsi	Kablo Kesiti	3x1,5 TTR	3x2,5 TTR	3x4 TTR	4x1,5 TTR	4x2,5 TTR	4x4 TTR	5x1,5 TTR	5x2,5 TTR	5x4 TTR
M130		120	100	75	100	80	55	100	70	50

X = 0 Borulu Makara X = 1 Arabalı Makara X = 2 Tekerlekli Makara



130.516.012







132.532.012



131.516.021

M140 Kablosuz Makaralar

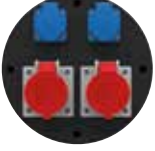
M140 Metal Gövdeli

Ürün Kodu	14X.416.022	14X.516.022	14X.425.022	14X.432.022	14X.532.022
Makara Göbekleri					
Açıklama	2(4x16A) CEE + 2(1x16A) Pano Prizi	2(5x16A) CEE + 2(1x16A) Pano Prizi	2(4x25A) CEE + 2(1x16A) Pano Prizi	2(4x32A) CEE + 2(1x16A) Pano Prizi	2(5x32A) CEE + 2(1x16A) Pano Prizi
Makara Fiyat	1.402,00 TL	1.422,00 TL	1.322,00 TL	1.482,00 TL	1.532,00 TL
Tekerlekli Makara Fiyat	1.567,00 TL	1.577,00 TL	1.477,00 TL	1.637,00 TL	1.687,00 TL
Arabalı Makara Fiyat	1.770,00 TL	1.780,00 TL	1.680,00 TL	1.840,00 TL	1.890,00 TL

Makara Cinsi	Kablo Kesiti	3x1,5 TTR	3x2,5 TTR	3x4 TTR	4x1,5 TTR	4x2,5 TTR	4x4 TTR	5x1,5 TTR	5x2,5 TTR	5x4 TTR
M100		50	40	30	-	-	-	-	-	-
M120		100	75	60	80	65	45	75	50	40
M130		120	100	75	100	80	55	100	70	50
M140		180	140	125	170	130	100	135	110	90
M150		60	50	40	-	-	-	-	-	-
M160		60	50	40	50	35	25	-	-	-



140.432.022











142.516.022



141.532.022

1 KV Bara Mesnet İzolatörleri

Fiçı Tip 1 KV	Ürün Kodu	Açıklama		Fiyat
	722.120.005	M5 Kör Somunlu Fiçı Tip	250	13,00 TL
	722.120.008	M8 Kör Somunlu Fiçı Tip	50	36,00 TL
	722.120.010	M10 Kör Somunlu Fiçı Tip	50	42,00 TL
722.120.005				
	722.102.005	M5 Cıvatalı Fiçı Tip	250	20,00 TL
	722.102.008	M8 Cıvatalı Fiçı Tip	50	29,00 TL
	722.102.010	M10 Cıvatalı Fiçı Tip	50	36,00 TL
722.102.005				
	722.111.005	M5 Cıvata + Kör Somunlu Fiçı Tip	250	33,00 TL
	722.111.008	M8 Cıvata + Kör Somunlu Fiçı Tip	50	34,00 TL
	722.111.010	M10 Cıvata + Kör Somunlu Fiçı Tip	50	39,00 TL
722.111.005				
Konik Tip 1 KV	Ürün Kodu	Açıklama		Fiyat
	722.220.006	M6 Kör Somunlu Konik Tip	100	20,00 TL
	722.220.008	M8 Kör Somunlu Konik Tip	50	12,00 TL
	722.220.010	M10 Kör Somunlu Konik Tip	50	17,00 TL
722.220.006				
	722.202.006	M6 Cıvatalı Konik Tip	100	36,00 TL
	722.202.008	M8 Cıvatalı Konik Tip	50	29,00 TL
	722.202.010	M10 Cıvatalı Konik Tip	50	32,00 TL
722.202.006				
	722.211.006	M6 Cıvata + Kör Somunlu Konik Tip	100	41,00 TL
	722.211.008	M8 Cıvata + Kör Somunlu Konik Tip	50	35,00 TL
	722.211.010	M10 Cıvata + Kör Somunlu Konik Tip	50	38,00 TL
722.211.006				

Tarak İzolatörler

Ürün Kodu	Açıklama		Fiyat
722.331.000	Tek Bara Taraklı - Üç Fazlı	24	47,00 TL
722.332.000	Çift Bara Taraklı - Üç Fazlı	24	53,00 TL
722.333.000	Üç Bara Taraklı - Üç Fazlı	24	100,00 TL
722.341.000	Tek Bara Taraklı - Üç Fazlı + Nötr	24	88,00 TL
722.342.000	Tek Bara Taraklı - Üç Fazlı + Nötr	24	102,00 TL

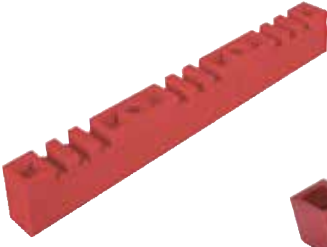

722.333.000

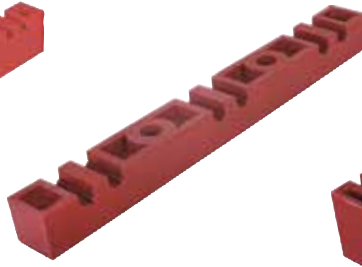

722.332.000

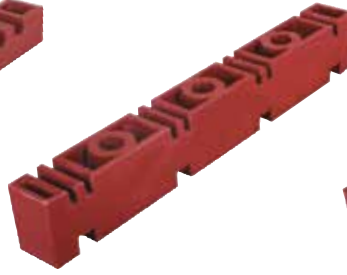

722.342.000



722.331.000

1N Serisi İzolatörler

Ürün Kodu	Açıklama		Fiyat
722.100.001	1N -B M16 Kör Somunlu	12	179,00 TL
722.100.002	1N -C M16 Kör Somunlu	12	179,00 TL
722.100.003	1N -D M16 Kör Somunlu	12	188,00 TL
722.100.004	1N -K M16 Kör Somunlu	12	183,00 TL
722.100.005	1N - 500 M16 Kör Somunlu	12	105,00 TL
722.100.008	Bara Tutucu Serfil	12	22,00 TL



722.100.003



722.100.004



722.100.005



722.100.001



722.100.002



722.100.008

Seyyar Lamba - Baladoz**Anahtarlı****Ürün Kodu**

785.000.010
785.105.010
785.110.010
785.115.010
785.120.010
785.125.010

Açıklama

Kablosuz
5m. Kablolu
10m. Kablolu
15m. Kablolu
20m. Kablolu
25m. Kablolu

Fiyat

107,00 TL
269,00 TL
293,00 TL
386,00 TL
480,00 TL
569,00 TL

Anahtarsız**Ürün Kodu**

785.000.020
785.105.020
785.110.020
785.115.020
785.120.020
785.125.020

Açıklama

Kablosuz
5m. Kablolu
10m. Kablolu
15m. Kablolu
20m. Kablolu
25m. Kablolu

Fiyat

97,00 TL
191,00 TL
277,00 TL
366,00 TL
455,00 TL
549,00 TL

Seyyar Lamba - Çanaklı Baladoz**Anahtarlı****Ürün Kodu**

786.000.010
786.107.010

Açıklama

Kablosuz
7.5m. Kablolu

Fiyat

299,00 TL
479,00 TL

Anahtarsız**Ürün Kodu**

786.000.020
786.107.020

Açıklama

Kablosuz
7.5m. Kablolu

Fiyat

285,00 TL
425,00 TL

Bant Armatür Soketleri



787.100.100
Tekli Klasik
19,80 TL / Tk.



787.100.200
Çiftli Klasik
28,60 TL / Tk.



787.300.000
Starter Yuvası
8,80 TL / Tk.



Fiyat Sorunuz.

24V 100W

Kablolar



725.315.113
Çift Topraklı Fişli Kablo
3G 1,5 H0VV-F 3m.



725.325.113
Çift Topraklı Fişli Kablo
3G 2,5 H0VV-F 3m.



725.310.212
Güç Kablosu
3G 1 H0VV-F 1,8m.



725.315.123
İngiliz Fişli Kablo
3G 1,5 H0VV-F 3m.

Kablolar için fiyat sorunuz.

Kablo Bağı



Ürün Kodu

Açıklama



Fiyat

736.230.210	2.5 x 100	100	0,15 TL
736.230.214	2.5 x 140	100	0,22 TL
736.230.220	2.5 x 200	100	0,32 TL
736.230.315	3.6 x 150	100	0,36 TL
736.230.320	3.6 x 205	100	0,47 TL
736.230.325	3.6 x 250	100	0,58 TL
736.230.330	3.6 x 300	100	0,71 TL
736.230.337	3.6 x 370	100	0,90 TL
736.230.420	4.8 x 200	100	0,67 TL
736.230.425	4.8 x 250	100	0,81 TL
736.230.430	4.8 x 300	100	1,10 TL
736.230.435	4.8 x 350	100	1,16 TL
736.230.440	4.8 x 400	100	1,34 TL
736.230.845	8 x 450	100	2,60 TL
722.230.855	8 x 550	100	3,40 TL
722.230.976	9 x 762	100	7,30 TL
722.230.994	9 x 940	100	8,40 TL



İskan ERDOĞMUŞ
Satış Koordinatörü

Bölgesi

İstanbul, Bursa, Muğla, Bilecik, Eskişehir, Kütahya,
Burdur, Isparta, Uşak, Antalya

Telefon

0532 417 31 86

E-Posta

iskanerdogmus@temteknik.com

Ersoy ERDOĞAN
Satış Sorumlusu

Kocaeli, Sakarya, Düzce, Ankara, Kırıkkale, Bolu,
Konya, Aksaray, Kırşehir, Nevşehir, Afyon, Karabük
Zonguldak, Yalova

0535 107 70 65

ersoy@temteknik.com

Mahmut ERDAL
Satış Sorumlusu

İstanbul Anadolu Yakası, İzmir, Aydın, Manisa, Denizli
Balıkesir, Çanakkale, Trakya Bölgesi

0531 381 04 38

mahmut@temteknik.com

Burhan KOÇAK
Satış Sorumlusu

İstanbul Avrupa Yakası, Doğu Anadolu Bölgesi,
Güneydoğu Anadolu Bölgesi, Karadeniz Bölgesi

0533 694 10 19

burhan@temteknik.com

TEM®

TEM TEKNİK ELEKTRİK MALZEMELERİ SANAYİ VE TİCARET ANONİM ŞİRKETİ



Selimpaşa Ortaköy Sanayi Bölgesi, İltar Bulvarı, Mor Menekşe Sok, No:5 34590
SİLİVRİ / İSTANBUL / TÜRKİYE



+90 212 485 19 00



+90 212 485 15 33



www.temteknik.com



info@temteknik.com