



ÖZEL-MAX 2023

80. YIL  
[www.ozbekenerji.com.tr](http://www.ozbekenerji.com.tr)

# Hakkımızda

1943 yılında Zeki Özdemir tarafından Radyo Emek Atölyesi olarak başlanan ticari yaşam, Zeki Özdemir Ticarethanesi olarak devam etmiş, 1963 yılında Zeki - Eray Özdemir olarak Elmak Dahili Ticaret Mümessillik - İthalat bünyesinde gelişimini Arçelik Beyaz Eşya Bayiliğini'nde katarak sürdürmüştür. 1998 yılında gelindiğinde sermaye şirketine dönüştürülerek "Konya Elmak Elektrik A.Ş." adını almıştır.

Şu anda Elektrik endüstrisinde 80 yılı aşkın deneyime sahip bir şirket olan Konya Elmak Elektrik A.Ş.'nin 3. Kuşağı olarak sizlere hoşgeldiniz diyoruz.

Seksen yılı aşkın süredir Konya Elmak Elektrik Ticaret ve Sanayi Anonim Şirketi;Türkiye'nin dört bir yanındaki müşterilerine en kaliteli elektrik ürünlerini temin etmektedir.

Mükemmeliğe ve müşteri memnuniyetine olan bağlılığımız bizi sektörde öne çıkararak en güvenilir isimlerden biri yapmıştır.Konya Elmak A.Ş. ailesi olarak, elektrik endüstrisinde güvenilirlik ve performansın önemini anlıyoruz.

Bu nedenle yalnızca endüstri standartlarını karşılayan ürünleri ithal ediyoruz ve sektördeki en saygın tedarikçiler tarafından üretilen ürünleri sunuyoruz.

Geniş ürün yelpazemiz birçok endüstriyel ürünü kapsıyor ve teknolojik gelişmelere ayak uydurmak için envanterimizi sürekli güncelliyoruz.

Konusunda uzman ve tecrübeli çalışanlarımız, sorularınızı yanıtlamak ve en iyi ürünleri tedarik konusunda yardımcı olmak için her zaman hazırdır. Ayrıca, alışveriş deneyiminizi mümkün olduğunca kolay ve verimli hale getirmek için 2022 yılında online e-ticaret sitemiz [www.onoffmax.com](http://www.onoffmax.com) ve buna bağlı mobil uygulamalarımız hizmete girmiştir.

Konya Elmak A.Ş. , müşterilerine sorun yaşatmadan pazarlama faaliyetlerini ve malzeme teminini yürütmekte, sahip olduğu zengin ürün kapasitesi, gelişime, yenilenmeye açık vizyonumuz ile tüm Türkiye çapında hizmetimizi sürdürerek elektrik sektöründe yerini güçlü bir şekilde almıştır.

Saygılarımızla.

[www.el-max.com.tr](http://www.el-max.com.tr)

[www.ozbekenerji.com.tr](http://www.ozbekenerji.com.tr)

80.  
Yil



since 1943  
**eL-max**

[www.el-max.com.tr](http://www.el-max.com.tr)



[www.ozbekenenerji.com.tr](http://www.ozbekenenerji.com.tr)



# Indeks

MALZEME KODU	SAYFA NO	B.FİYATI
SEM123	51	6.06 \$
SEL123	52	5.67 \$
SEL123R	52	7.22 \$
SOM101	52	6.29 \$
SOM102	52	6.29 \$
CSA001	53	15.30 \$
CSA003	53	15.30 \$
CSA004	53	15.30 \$
CSA012	53	15.30 \$
CSA031	53	15.30 \$
CSA061	53	15.30 \$
CSA071	53	15.30 \$
15G0B	54	3.35 \$
15G022B	54	3.60 \$
15G021B	54	3.60 \$
15GWB	54	3.33 \$
15GW22B	54	3.05 \$
15GW3B	54	4.73 \$
15GW2B	55	3.33 \$
XAPY	55	0.95 \$
15-1C25	56	1.19 \$
151-1C25	56	1.19 \$
152-1C25	56	1.19 \$
153-1C25	56	1.19 \$
154-1C25	56	1.19 \$
155-1C25	56	1.19 \$
156-1C25	56	1.19 \$
ELX-IY-3005	57	0.145 ₺
IY3007	57	0.145 ₺
IY3010	57	0.145 ₺
IY3015	57	0.158 ₺
IY3025	57	0.202 ₺
IY3040	57	0.333 ₺
IY3060	57	0.452 ₺
IY3100	57	0.572 ₺
IY3160	57	0.813 ₺
IY3250	57	1.40 ₺
IY3350	57	1.68 ₺
IY3500	57	3.20 ₺
ELX-IY2005	57	0.145 ₺
IY2007	57	0.145 ₺
IY2010	57	0.145 ₺
IY2015	57	0.158 ₺
IY2025	57	0.202 ₺
IY2040	57	0.333 ₺
IY2060	57	0.452 ₺
IY2100	57	0.572 ₺
IY2160	57	0.813 ₺
IY2250	57	1.40 ₺
IY2350	57	1.68 ₺
IY2500	57	3.20 ₺
ELX-CY23005	57	0.256 ₺
CY23007	57	0.269 ₺
CY23010	57	0.286 ₺
CY23015	57	0.346 ₺
CY23025	57	0.565 ₺
CY23040	57	0.650 ₺
CY23060	57	0.805 ₺
CY23100	57	1.284 ₺
CY23160	57	1.55 ₺
ELX-YU301	58	0.659 ₺
YU401	58	0.685 ₺
YU501	58	0.692 ₺
YU601	58	1.087 ₺
YU801	58	1.12 ₺
ELX-YU302	58	0.840 ₺
YU402	58	0.840 ₺
YU502	58	0.855 ₺
YU602	58	1.216 ₺
YU802	58	1.218 ₺
YU1002	58	1.220 ₺
ELX-YU406	58	1.77 ₺
YU506	58	1.77 ₺
YU606	58	1.99 ₺
YU806	58	2.53 ₺
YU1006	58	2.56 ₺
YU1206	58	2.61 ₺
YU1202	58	1.50 ₺
ELX-CU-3001	58	0.60 ₺
CU4001	58	0.611 ₺
CU5001	58	0.65 ₺
CU6001	58	0.736 ₺
ELX-CU-3002	59	0.675 ₺
CU4002	59	0.693 ₺
CU5002	59	0.705 ₺
CU6002	59	0.948 ₺
ELX-CU-4006	59	1.56 ₺
CU5006	59	1.60 ₺
CU6006	59	2.12 ₺
CU8006	59	2.43 ₺
ELX-K-101	59	0.711 ₺
K102	59	0.837 ₺
K106	59	2.10 ₺
ELX-BD-1040	59	1.90 ₺
BD2050	59	2.12 ₺
BE2050	60	1.81 ₺
ELX-FFD-1488	60	1.022 ₺
FFD1638	60	1.18 ₺
FFD2488	60	1.130 ₺
FFD2638	60	1.180 ₺
FFD5638	60	1.480 ₺
ELX-FD-1488	61	0.76 ₺
FD1638	61	0.88 ₺
FD2638	61	1.10 ₺
FD5638	61	1.20 ₺
ELX-FE-1288	62	0.606 ₺
FE1488	62	0.606 ₺

MALZEME KODU	SAYFA NO	B.FİYATI
FE1638	62	0.723 ₺
FE2488	62	0.606 ₺
FE2638	62	0.790 ₺
FE5638	62	0.945 ₺
ELX-SF1D	62	0.660 ₺
SF2D	62	0.660 ₺
SF1-2D	62	0.425 ₺
SF1-DMINI	62	0.515 ₺
SF1-DKILIF	62	0.315 ₺
ELX-SF-1ECK	62	0.685 ₺
SF1EUI	62	0.860 ₺
ELX-SKN-2,5	62	0.66 ₺
SKN4	62	1.24 ₺
SKN6	62	1.9 ₺
SKN8	62	1.9 ₺
SKN10	62	2.17 ₺
SKPE-1606	63	0.255 \$
1608	63	0.255 \$
2508	63	0.452 \$
3508	63	0.626 \$
5010	63	0.783 \$
7010	63	1.22 \$
9512	63	1.45 \$
12012	63	2.17 \$
15012	63	3.05 \$
18516	63	3.88 \$
24016	63	5.70 \$
EM16	63	0.370 \$
EM25	63	0.520 \$
EM35	63	0.750 \$
EM50	63	0.835 \$
EM70	63	1.39 \$
EM95	63	1.60 \$
EM120	63	2.30 \$
EM150	63	3.48 \$
EM185	63	4.17 \$
EM240	63	6.11 \$
SKPS-10-06	64	0.398 \$
1008	64	0.398 \$
1606	64	0.50 \$
1608	64	0.50 \$
SKPS-2506	64	0.796 \$
2508	64	0.796 \$
2510	64	0.824 \$
SKPS-35-06	64	1.064 \$
3508	64	1.064 \$
3510	64	1.064 \$
5008	64	1.638 \$
5010	64	1.638 \$
SKPS-50-12	64	1.712 \$
7008	64	2.22 \$
7010	64	2.50 \$
7012	64	2.22 \$
SKPS-95-08	64	2.50 \$
9510	64	2.36 \$
9512	64	2.36 \$
SKPS-120-10	64	3.37 \$
12012	64	3.24 \$
15010	64	5.18 \$
15012	64	5.09 \$
18510	64	6.20 \$
18512	64	5.92 \$
18516	64	5.92 \$
SKPS-240-10	64	8.33 \$
24012	64	7.96 \$
24016	64	7.96 \$
ELX-SKPB-16	65	3.00 \$
ELX-SKPB-25	65	3.00 \$
SKPB35	65	3.00 \$
SKPB50	65	3.70 \$
SKPB70	65	3.70 \$
SKPB95	65	3.70 \$
SKPB120	65	6.55 \$
SKPB150	65	6.55 \$
SKPB185	65	11.0 \$
SKPB240	65	11.0 \$
SKPB-2-300	65	12.90 \$
SKPB-2-400	65	20.70 \$
2007	67	67.80 ₺
2010	67	79.00 ₺
2012	67	93.60 ₺
2015	67	105 ₺
2020	67	147 ₺
2022	67	162 ₺
2025	67	184.0 ₺
2030	67	210.0 ₺
1407	67	139.0 ₺
1410	67	155.0 ₺
1412	67	174 ₺
1415	67	224 ₺
1420	67	286 ₺
1422	67	309 ₺
1507	67	277 ₺
1510	67	298 ₺
1512	67	334 ₺
1515	67	412.5 ₺
1520	67	538.5 ₺
1522	67	573 ₺
1525	67	664.5 ₺
3207	68	509.9 ₺
3210	68	744.8 ₺
3212	68	882 ₺
3215	68	1100 ₺
3220	68	1432 ₺
3222	68	1489 ₺
3307	68	618.8 ₺

MALZEME KODU	SAYFA NO	B.FİYATI
3310	68	878 ₺
3312	68	1050 ₺
3315	68	1318 ₺
3320	68	1747 ₺
3322	68	1909 ₺
1004	69	12.60 ₺
1005	69	13.36 ₺
1006	69	17.85 ₺
1007	69	18.80 ₺
1009	69	21.00 ₺
1010	69	23.90 ₺
1012	69	30.50 ₺
1106	69	29.80 ₺
1107	69	32.75 ₺
1110	69	40 ₺
1112	69	42.90 ₺
1115	69	52.60 ₺
1120	69	68.80 ₺
1125	69	87 ₺
1130	69	124 ₺
ELX2.5-2	70	0.114 \$
2.5-3	70	0.124 \$
2.5-4	70	0.146 \$
2.5-5	70	0.170 \$
2.5-6	70	0.198 \$
2.5-8	70	0.246 \$
ELX-412	70	0.219 \$
413	70	0.284 \$
414	70	0.350 \$
415	70	0.410 \$
ELX-KB 2.5X100	71	0.156 ₺
2.5-150	71	0.234 ₺
2.5-200	71	0.328 ₺
ELX-KB 3.6X150	71	0.382 ₺
3.6X200	71	0.500 ₺
3.6X250	71	0.601 ₺
3.6X300	71	0.765 ₺
3.6X370	71	0.960 ₺
ELX-KB 4.8X200	71	0.703 ₺
4.8X250	71	0.828 ₺
4.8X300	71	1.046 ₺
4.8X380	71	1.305 ₺
4.8X450	71	1.593 ₺
4.8X500	71	1.796 ₺
ELX-KB-8X300	71	2.031 ₺
8X380	71	2.340 ₺
8X450	71	2.810 ₺
8X550	71	3.830 ₺
8X650	71	5.150 ₺
8X750	71	5.620 ₺
ELX-KB-9X900	71	9.95 ₺
ELX-KB 9X950	71	10.46 ₺
9X1000	71	10.86 ₺
9X1200	71	12.80 ₺
ELX-YK 20	71	1.10 ₺
YK 25	71	1.5 ₺
YK 30	71	1.98 ₺
YK 40	71	3.95 ₺
COB61	73	4 \$
COB62	73	5.25 \$
COB63	73	6.875 \$
COB64	73	9.375 \$
COBC1	73	16.25 \$
COBC2	73	22.5 \$
COBC3	73	29.37 \$
COBC4	73	35 \$
K-B-2	74	11.90 \$
AP-9	74	33.6 \$
AP-9-KAB	74	37.0 \$
FS-1	74	6.85 \$
FS-2	74	8.28 \$
FS-3	74	11.44 \$
KOMPAKT AKSİYEL METAL FAN TAIDA	75	
KOMPAKT AKSİYEL METAL FAN SALZER	76	
DEMEX MARKA FANLAR TURBO FANLAR	77	
FAN FİLTRESİ-FAN TELİ DEMEX TERMOSTATLAR	78	
DEMEX-300 CATI FANI	79	104.20 \$
DEMEX-600 CATI FANI	80	138.9 \$
DEMEX-900 CATI FANI	81	156.2 \$
DEMEX-1250 CATI FANI	82	173.6 \$
CAL-16C	66	4.60 \$
CAL-25C	66	4.60 \$
CAL-35C	66	4.60 \$
CAL-50C	66	6.20 \$
CAL-70C	66	6.20 \$
CAL-95C	66	6.20 \$
CTL-10	66	3.10 \$
CTL-16	66	3.10 \$
CTL-25	66	3.10 \$
CTL-35	66	3.38 \$
CTL-50	66	3.80 \$
CTL-70	66	4.45 \$
CTL-95	66	6.00 \$
CTL-120	66	8.00 \$

- 1-2 ▪ İNDEKS
- 5-6 ▪ İÇİNDEKİLER
- 7-10 ▪ OTOMATİK SİGORTA
- 11 ▪ KAÇAK AKIM RÖLELERİ
- 12 ▪ KONTAKTÖR UNMC SERİSİ
- 13-14 ▪ KONTAKTÖR D SERİSİ
- 15 ▪ YARDIMCI KONTAKTÖR BLOK
- 16 ▪ TERMİK RÖLELER
- 17 ▪ MİNİ KONTAKTÖR/MİNİ TERMİK RÖLE
- 17 ▪ SESSİZ KONTAKTÖR MOTOR KORUMA ŞALTERİ
- 17 ▪ DARBE AKIM ANAHTARI
- 17 ▪ BOŞ KUMANDA KUTULARI
- 19-20 ▪ KUTULU MONTAJLI ÜRÜNLER
- 21-24 ▪ KUMANDA KUTULARI
- 26 ▪ ASANSÖR KUMANDA SİSTEMİ VE KUYU BİLEŞENLERİ
- 25 ▪ BOY FOTOSELI
- 27 ▪ ASANSÖR PANOSU - EMC FİLTRE FRENLEME DİRENÇ
- 28 ▪ DEPREM SENSÖRÜ - DUMAN DEDEKTÖRÜ
- 30-35 ▪ ASANSÖR GRUBU MALZEMELERİ
- 36 ▪ KABLO KANALLARI
- 37 ▪ BUZZER - AKÜLER
- 37 ▪ KÖPRÜ DİYOT MIKNATIS IŞIKLI MİNİ ANAHTAR
- 38 ▪ 24 V GÜÇ KAYNAKLARI
- 39-42 ▪ LAY 5 BUTON SERİLERİ
- 42 ▪ JOYSTICK KONTROL
- 42 ▪ POTANSİYOMETRE



# 2023 FİYAT KATALOGU

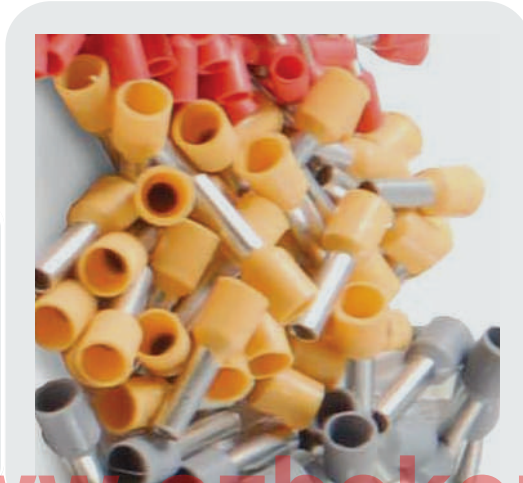
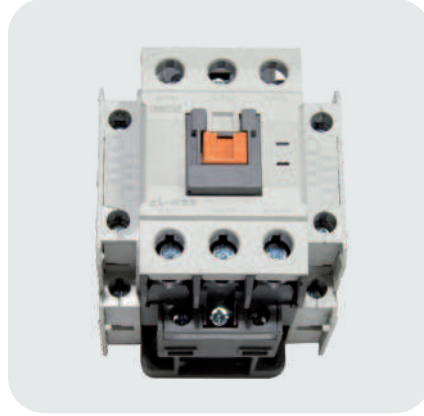

Since 1943  
**el-max**

- 43-47 ▪ ELX2M PLASTİK BUTON SERİLERİ
- 48 ▪ SİRENLER - BUZZER VE LEDLİ SİNYAL LAMBALARI
- 49 ▪ LEDLİ VOLTMETRE
- 49 ▪ AMPERMETRE SİNYAL LAMBALARI
- 50-52 ▪ XCK PLASTİK GÖVDELİ LİMİT SWITCHLER
- 53 ▪ CSA METAL GÖVDELİ LİMİT SWITCH
- 54-56 ▪ MİNİ VE MAKRO SWITCHLER (SILVER CONTACT)
- 57-58 ▪ İZOLELİ KABLO YÜKSÜKLERİ (BAKIR COPPER)
- 59 ▪ İZOLELİ PABUÇLAR
- 60-62 ▪ TERMİNAL
- 63-64 ▪ EKONOMİK KABLO PABUÇLARI VE EK MUFLAR
- 65-66 ▪ BİMETALLER (AL-CU)
- 67-68 ▪ DAĞITIM ÜNİTESİ
- 69 ▪ TOPRAKLAMA KLEMENSLER
- 70 ▪ BUAT KLEMENSLER
- 71 ▪ PLASTİK KABLO BAĞLARI
- 73-74 ▪ VİNÇ KUMANDA BUTONLARI - AYAK PEDALLARI
- 75 ▪ KOMPAKT AKSİYEL METAL FAN - TAIDA
- 76 ▪ KOMPAKT AKSİYEL METAL FAN - SALZER
- 77 ▪ DEMEX MARKA FANLAR - TURBO FANLAR
- 78 ▪ FAN FİLTRESİ - FAN TELİ - DEMEX TERMOSTATLAR
- 79 ▪ DEMEX - 300
- 80 ▪ DEMEX - 600
- 81 ▪ DEMEX - 900
- 82 ▪ DEMEX - 1250
- 83-84 ▪ BELGELERİMİZ
- 85-86 ▪ NOT

## Otomatik Sigorta

### 1 Kutuplu Otomatik Sigortalar 6 kA



#### Teknik Özellikler

ÜRÜN KODU	TİPİ	ANMA AKIMI (A)	ANMA GERİLİMİ	AÇIKLAMA	K. ADEDİ	FİYAT
EMC-9-63	C	2 A	230/400 V	Otomatik Sigorta	240	<b>2,78 \$</b>
EMC-9-63	C	4 A	230/400 V	Otomatik Sigorta	240	<b>2,78 \$</b>
EMC-9-63	C	6 A	230/400 V	Otomatik Sigorta	240	<b>2,78 \$</b>
EMC-9-63	C	10 A	230/400 V	Otomatik Sigorta	240	<b>2,44 \$</b>
EMC-9-63	C	16 A	230/400 V	Otomatik Sigorta	240	<b>2,44 \$</b>
EMC-9-63	C	25 A	230/400 V	Otomatik Sigorta	240	<b>2,44 \$</b>
EMC-9-63	C	32 A	230/400 V	Otomatik Sigorta	240	<b>2,90 \$</b>
EMC-9-63	C	40 A	230/400 V	Otomatik Sigorta	240	<b>2,90 \$</b>
EMC-9-63	C	50 A	230/400 V	Otomatik Sigorta	240	<b>3,10 \$</b>
EMC-9-63	C	63 A	230/400 V	Otomatik Sigorta	240	<b>3,10 \$</b>

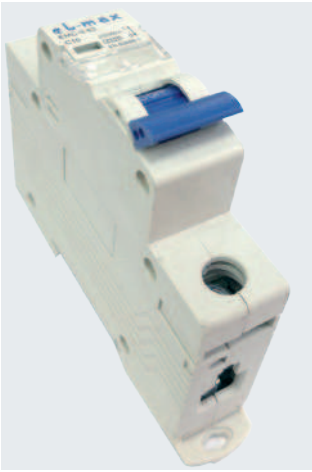



## Otomatik Sigorta

### 3 Kutuplu Otomatik Sigortalar 6 kA



#### Teknik Özellikler

ÜRÜN KODU	TİPİ	ANMA AKIMI (A)	ANMA GERİLİMİ	AÇIKLAMA	K. ADEDİ	FİYAT
EMC 3-9-63	C	10 A	400 V	Otomatik Sigorta	80	<b>8,50 \$</b>
EMC 3-9-63	C	16 A	400 V	Otomatik Sigorta	80	<b>8,50 \$</b>
EMC 3-9-63	C	20 A	400 V	Otomatik Sigorta	80	<b>8,50 \$</b>
EMC 3-9-63	C	25 A	400 V	Otomatik Sigorta	80	<b>8,50 \$</b>
EMC 3-9-63	C	32 A	400 V	Otomatik Sigorta	80	<b>8,79 \$</b>
EMC 3-9-63	C	40 A	400 V	Otomatik Sigorta	80	<b>8,79 \$</b>
EMC 3-9-63	C	50 A	400 V	Otomatik Sigorta	80	<b>9,76 \$</b>
EMC 3-9-63	C	63 A	400 V	Otomatik Sigorta	80	<b>9,76 \$</b>



## Otomatik Sigorta

### 3 Kutuplu Otomatik Sigortalar 10 kA

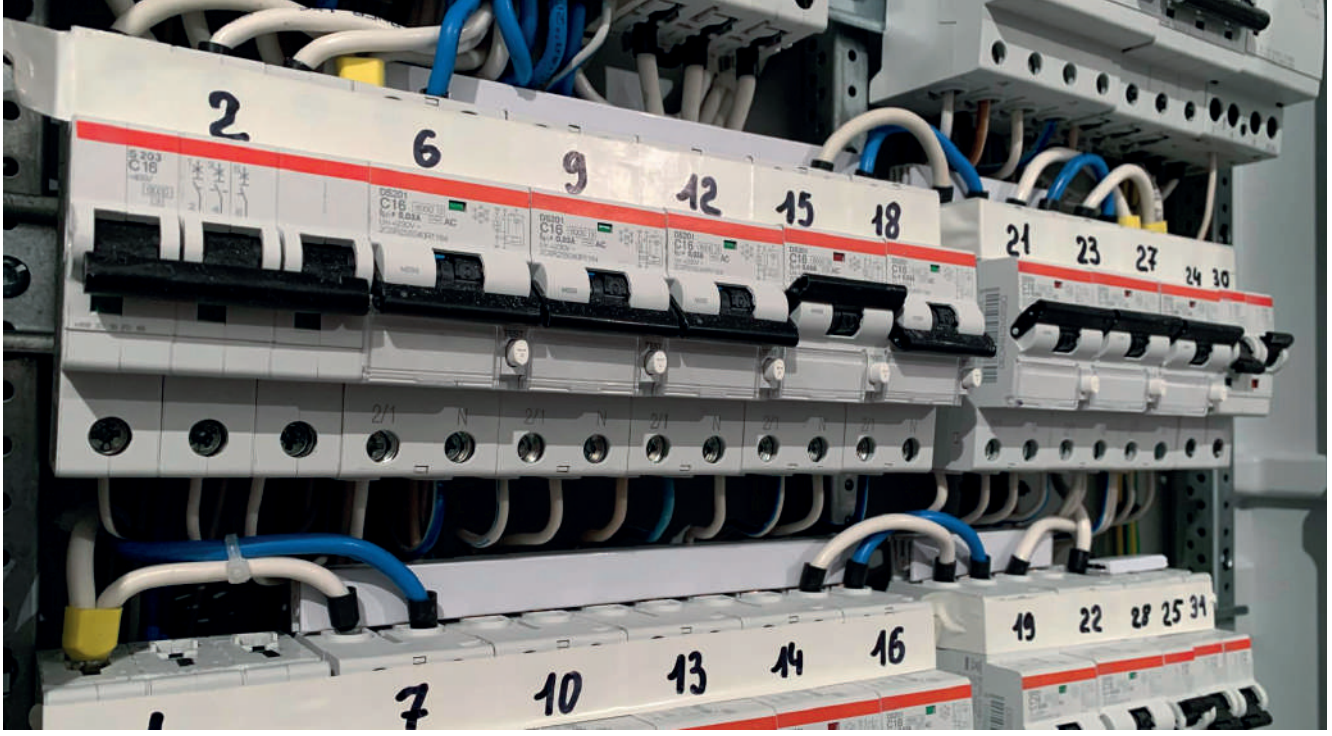

#### Teknik Özellikler

ÜRÜN KODU	TİPİ	ANMA AKIMI (A)	ANMA GERİLİMİ	AÇIKLAMA	K. ADEDİ	FİYAT
EMC 3-9-63	C	80 A	400 V	Otomatik Sigorta	60	<b>42,00 \$</b>
EMC 3-9-63	C	100 A	400 V	Otomatik Sigorta	60	<b>44,00 \$</b>
EMC 3-9-63	C	125 A	400 V	Otomatik Sigorta	60	<b>46,00 \$</b>



## Otomatik Sigorta

### 4 Kutuplu Otomatik Sigortalar 6 kA

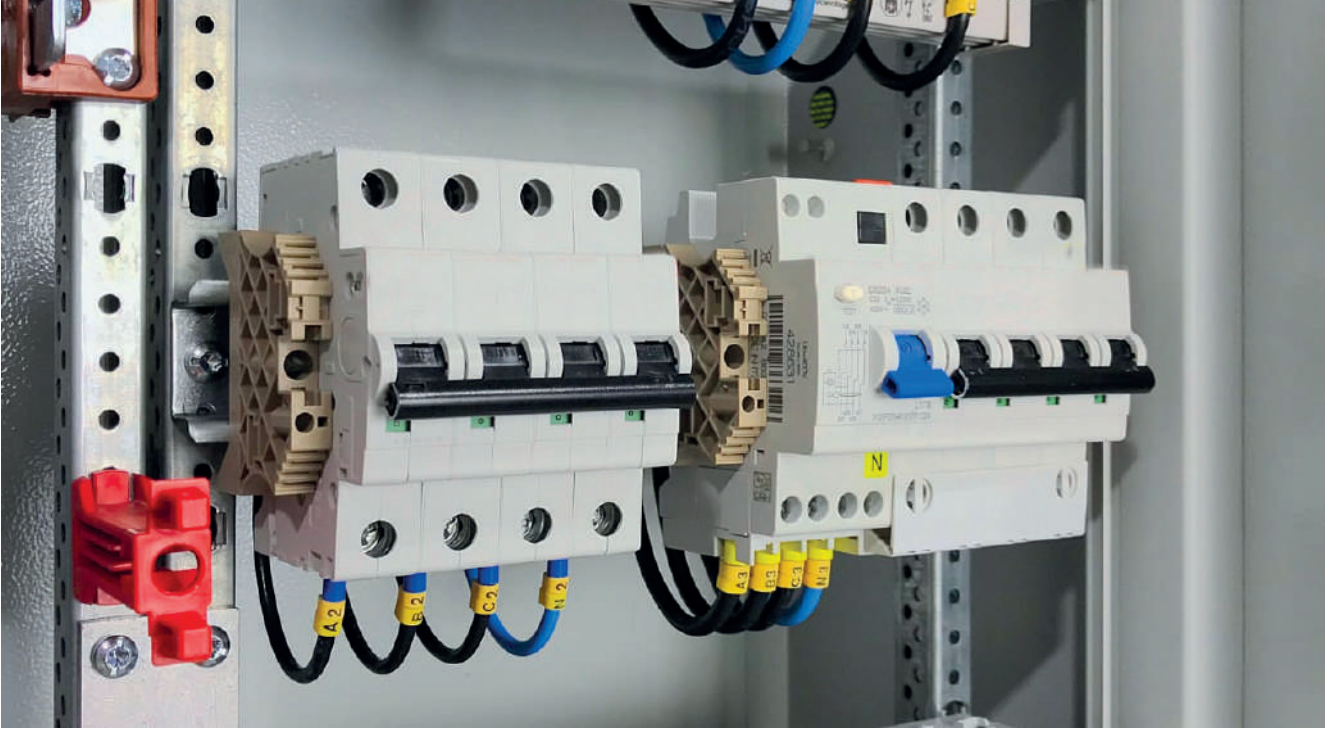

#### Teknik Özellikler

ÜRÜN KODU	TİPİ	ANMA AKIMI (A)	ANMA GERİLİMİ	AÇIKLAMA	K. ADEDİ	FİYAT
EMC 4-9-63	C	16 A	400 V	Otomatik Sigorta	60	<b>13,00 \$</b>
EMC 4-9-63	C	25 A	400 V	Otomatik Sigorta	60	<b>13,00 \$</b>
EMC 4-9-63	C	32 A	400 V	Otomatik Sigorta	60	<b>13,40 \$</b>
EMC 4-9-63	C	40 A	400 V	Otomatik Sigorta	60	<b>13,40 \$</b>
EMC 4-9-63	C	50 A	400 V	Otomatik Sigorta	60	<b>14,87 \$</b>
EMC 4-9-63	C	63 A	400 V	Otomatik Sigorta	60	<b>14,87 \$</b>



## Kaçak Akım Röleleri

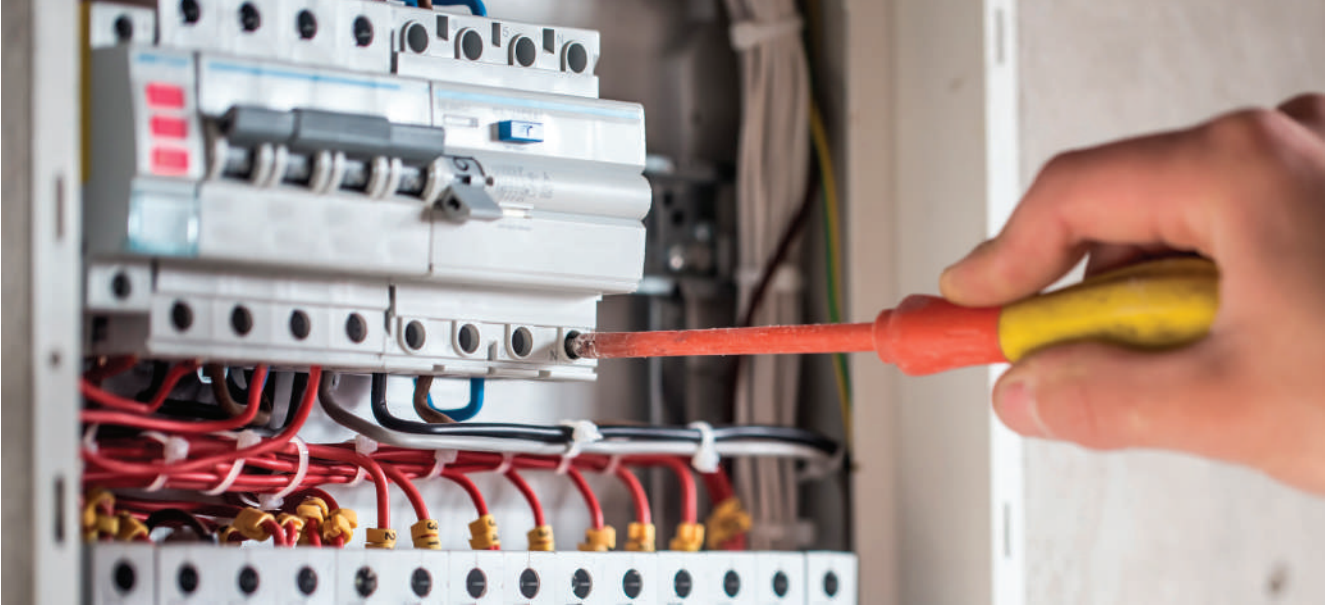

### 2 Kutuplu Kaçak Akım Rölesi 6 kA



#### Teknik Özellikler

ÜRÜN KODU	TİPİ	ANMA AKIMI (A)	ANMA GERİLİMİ	AÇIKLAMA	K. ADEDİ	FİYAT
ERB-2-25	30 mA	25 A	230 V	Kaçak Akım Rölesi	100	<b>21,59 \$</b>
ERB-2-25	300 mA	25 A	230 V	Kaçak Akım Rölesi	100	<b>21,59 \$</b>
ERB-2-32	30 mA	32 A	230 V	Kaçak Akım Rölesi	100	<b>21,59 \$</b>
ERB-2-32	300 mA	32 A	230 V	Kaçak Akım Rölesi	100	<b>21,59 \$</b>
ERB-2-40	30 mA	40 A	230 V	Kaçak Akım Rölesi	100	<b>21,59 \$</b>
ERB-2-40	300 mA	40 A	230 V	Kaçak Akım Rölesi	100	<b>21,59 \$</b>

### 4 Kutuplu Kaçak Akım Rölesi 6 kA



#### Teknik Özellikler

ÜRÜN KODU	TİPİ	ANMA AKIMI (A)	ANMA GERİLİMİ	AÇIKLAMA	K. ADEDİ	FİYAT
ERB-4-25	30 mA	25 A	230/400 V	Kaçak Akım Rölesi	50	<b>31,00 \$</b>
ERB-4-25	300 mA	25 A	230/400 V	Kaçak Akım Rölesi	50	<b>31,00 \$</b>
ERB-4-32	30 mA	32 A	230/400 V	Kaçak Akım Rölesi	50	<b>31,00 \$</b>
ERB-4-32	300 mA	32 A	230/400 V	Kaçak Akım Rölesi	50	<b>31,00 \$</b>
ERB-4-40	30 mA	40 A	230/400 V	Kaçak Akım Rölesi	50	<b>31,00 \$</b>
ERB-4-40	300 mA	40 A	230/400 V	Kaçak Akım Rölesi	50	<b>31,00 \$</b>
ERB-4-63	30 mA	63 A	230/400 V	Kaçak Akım Rölesi	50	<b>31,00 \$</b>
ERB-4-63	300 mA	63 A	230/400 V	Kaçak Akım Rölesi	50	<b>31,00 \$</b>

## Kontaktör

### 3 Fazlı Kontaktör UNMC Serisi

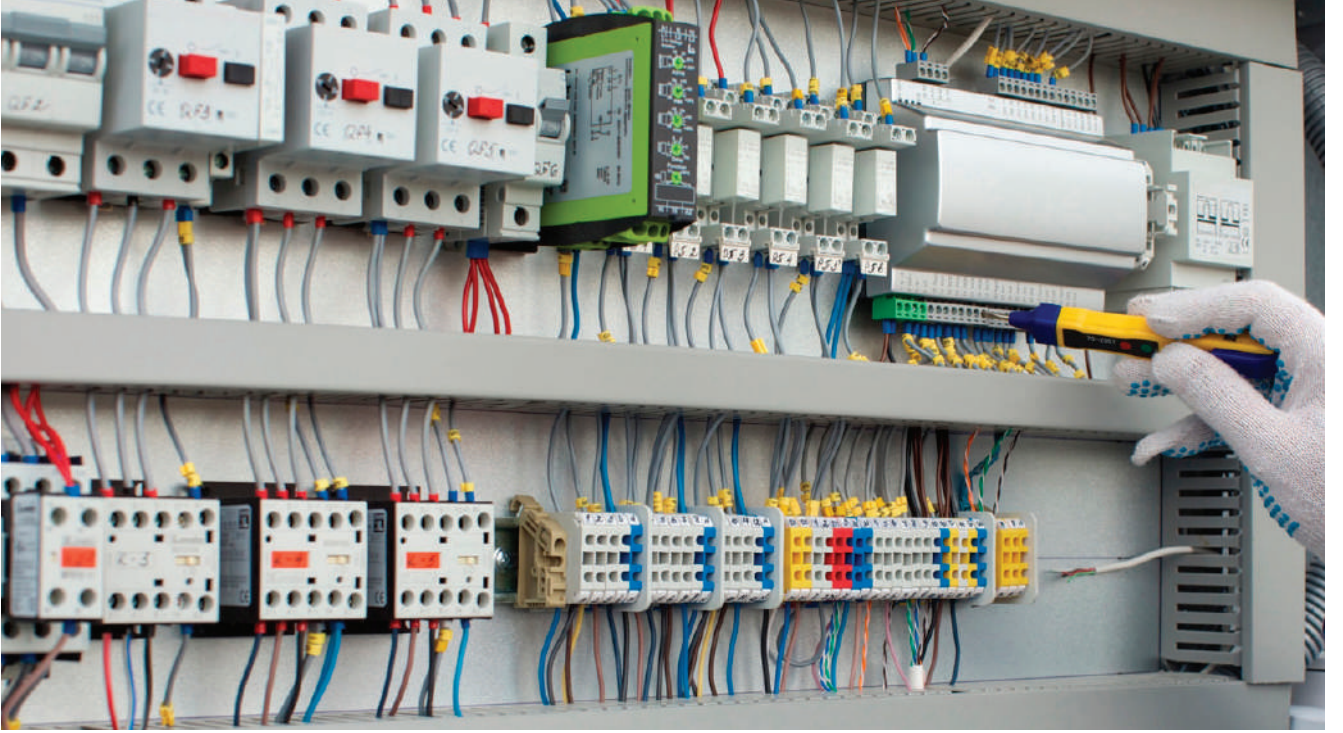

#### Teknik Özellikler

ÜRÜN KODU	ANMA AKIMI (A)	ANMA GÜCÜ (kW) 50/60Hz	YARDIMCI KONTAK	K. ADEDİ	FİYAT
UNMC-12	12 A	5,5 kW	1NO+1NC	50	<b>14,00 \$</b>
UNMC-18	18 A	7,5 kW	1NO+1NC	50	<b>18,80 \$</b>
UNMC-22	22 A	11 kW	1NO+1NC	50	<b>19,50 \$</b>
UNMC-32	32 A	15 kW	2NO+2NC	40	<b>32,75 \$</b>
UNMC-40	40 A	18,5 kW	2NO+2NC	40	<b>33,75 \$</b>
UNMC-65	65 A	30 kW	2NO+2NC	20	<b>58,00 \$</b>
UNMC-85	85 A	45 kW	2NO+2NC	20	<b>88,00 \$</b>

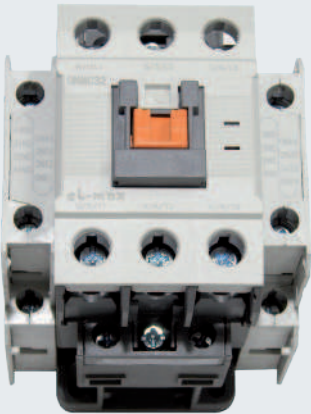

## Kontaktör

### 3 Fazlı Kontaktör ELX-D Serisi

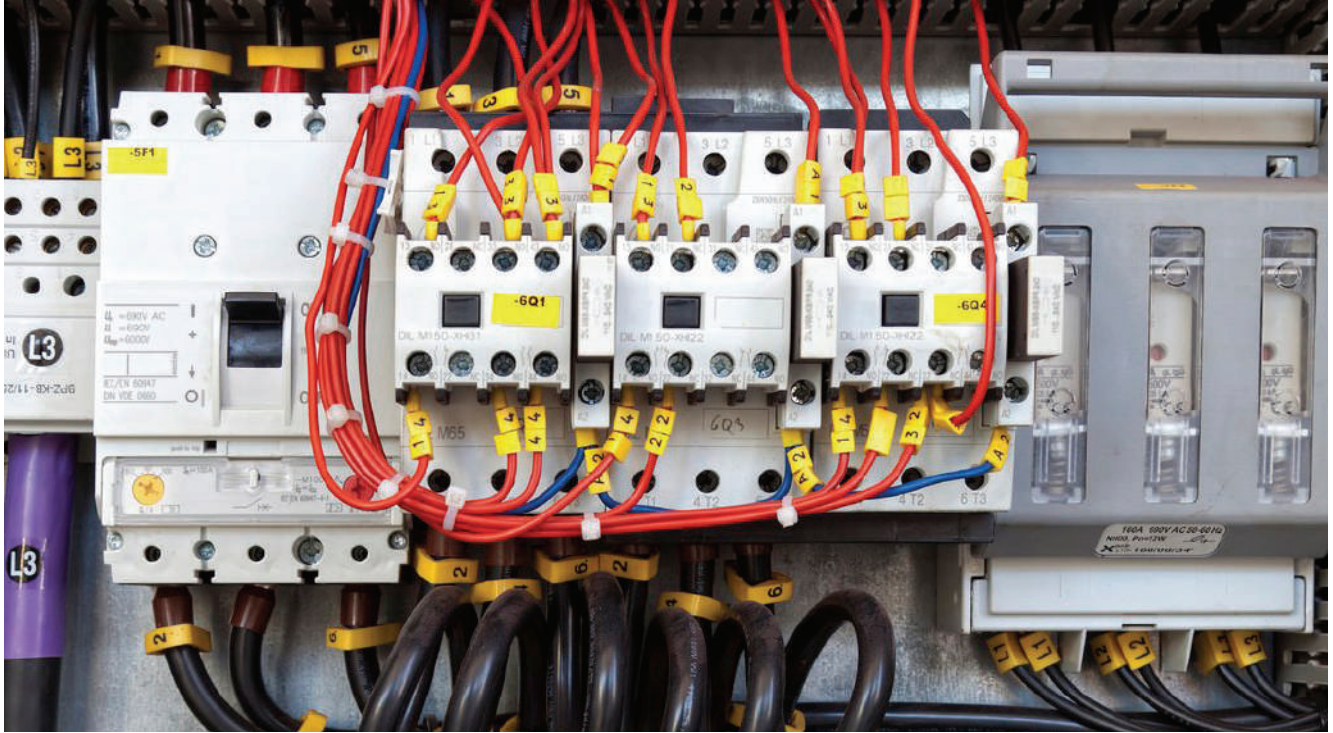

#### Teknik Özellikler

ÜRÜN KODU	ANMA AKIMI (A)	ANMA GÜCÜ (kW) 50/60Hz	YARDIMCI KONTAK	K. ADEDİ	FİYAT
ELX-D0910	9 A	4 kW	1NO	50	<b>10,55 \$</b>
ELX-D0901	9 A	4 kW	1NC	50	<b>10,55 \$</b>
ELX-D1210	12 A	5,5 kW	1NO	50	<b>10,83 \$</b>
ELX-D1201	12 A	5,5 kW	1NC	50	<b>10,83 \$</b>
ELX-D1810	18 A	7,5 kW	1NO	50	<b>12,77 \$</b>
ELX-D1801	18 A	7,5 kW	1NC	50	<b>12,77 \$</b>
ELX-D2510	25 A	11 kW	1NO	50	<b>18,00 \$</b>
ELX-D2501	25 A	11 kW	1NC	50	<b>18,00 \$</b>
ELX-D3210	32 A	15 kW	1NO	50	<b>23,88 \$</b>

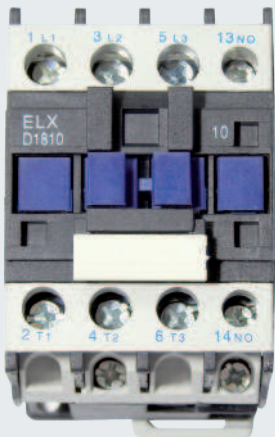

## Kontaktör

### 3 Fazlı Kontaktör ELX-D Serisi



#### Teknik Özellikler

ÜRÜN KODU	ANMA AKIMI (A)	ANMA GÜCÜ (kW) 50/60Hz	K. ADEDİ	FİYAT
ELX-D115	115 A	55 kW	4	<b>153,00 \$</b>
ELX-D150	150 A	75 kW	4	<b>162,00 \$</b>
ELX-D170	170 A	90 kW	4	<b>219,00 \$</b>

### Yardımcı Kontak Blođu



#### Teknik Özellikler

ÜRÜN KODU	BİRLİKTE KULLANILDIĐI KONTAKTÖR	YARDIMCI KONTAK	MONTAJ ŐEKLİ	FİYAT
LAD-8N11	ELX-D115 - ELX-D170	1NO+1NC	YAN	<b>10,60 \$</b>

## Yardımcı Kontak Blokları



### UNMC Serisi Yardımcı Kontak Bloğu



#### Teknik Özellikler

ÜRÜN KODU	BİRLİKTE KULLANILDIĞI KONTAKTÖR	YARDIMCI KONTAK	MONTAJ ŞEKLİ	FİYAT
AU-2	UNMC-9-UNMC-40	1NO+1NC	ÜST	<b>3,76 \$</b>
AU-4	UNMC-9-UNMC-40	2NO+2NC	ÜST	<b>6,25 \$</b>

### ELX-D Serisi Yardımcı Kontak Bloğu



#### Teknik Özellikler

ÜRÜN KODU	BİRLİKTE KULLANILDIĞI KONTAKTÖR	YARDIMCI KONTAK	MONTAJ ŞEKLİ	FİYAT
ELXDN11	ELX-D0910-ELX-D3210	1NO+1NC	ÜST	<b>3,75 \$</b>
ELXDN22	ELX-D0910-ELX-D3210	2NO+2NC	ÜST	<b>6,25 \$</b>



## Termik Röleler

### UNMR Serisi Termik Röle

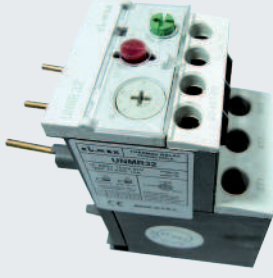

#### Teknik Özellikler

ÜRÜN KODU	ANMA AKIMI (A)	TERMİK AYAR SAHASI	K. ADEDİ	FİYAT
UNMR-32-10	10 A	7-10 A	50	<b>13,00 \$</b>
UNMR-32-13	13 A	9-13 A	50	<b>13,00 \$</b>
UNMR-32-18	18 A	13-18 A	20	<b>13,00 \$</b>
UNMR-32-25	25 A	17-25 A	20	<b>13,00 \$</b>
UNMR-32-32	32 A	23-32 A	20	<b>15,60 \$</b>
UNMR-85-65	65 A	45-65 A	20	<b>22,00 \$</b>
UNMR-85-85	85 A	63-85 A	20	<b>22,00 \$</b>

### ELX-D Serisi Termik Röle



#### Teknik Özellikler

ÜRÜN KODU	ANMA AKIMI (A)	TERMİK AYAR SAHASI	K. ADEDİ	FİYAT
UNTR1-D13-2,5	2,5 A	1,6-2,5 A	50	<b>10,80 \$</b>
UNTR1-D13-4	4 A	2,5-4 A	50	<b>10,80 \$</b>
UNTR1-D13-6	6 A	4-6 A	50	<b>10,80 \$</b>
UNTR1-D13-8	8 A	5-8 A	50	<b>10,80 \$</b>
UNTR1-D13-10	10 A	7-10 A	50	<b>10,80 \$</b>
UNTR1-D13-13	13 A	9-13 A	50	<b>10,80 \$</b>
UNTR1-D13-18	18 A	12-18 A	50	<b>10,80 \$</b>
UNTR1-D13-25	25 A	17-25 A	50	<b>10,80 \$</b>
UNTR1-D13-32	32 A	23-32 A	50	<b>10,80 \$</b>

### Raya Montaj Termik Röle



#### Teknik Özellikler

ÜRÜN KODU	ANMA AKIMI (A)	TERMİK AYAR SAHASI	K. ADEDİ	FİYAT
UNSRI-D59-4	4 A	2,5-4 A	50	<b>16,00 \$</b>
UNSRI-D59-6,3	6,3 A	4-6,3 A	50	<b>16,00 \$</b>
UNSRI-D59-10	10 A	6,3-10 A	50	<b>16,00 \$</b>
UNSRI-D59-16	16 A	10-16 A	50	<b>16,00 \$</b>
UNSRI-D59-25	25 A	16-25 A	50	<b>19,00 \$</b>
UNSRI-D59-40	40 A	25-40 A	50	<b>19,00 \$</b>
UNSRI-D59-57	57 A	40-57 A	50	<b>19,00 \$</b>
UNSRI-D59-63	63 A	57-63 A	50	<b>19,00 \$</b>

## Mini Kontaktör / Mini Termik Röle / Sessiz Kontaktör Motor Koruma Şalteri / Darbe Akım Anahtarı

### 3 Fazlı Mini Kontaktör



#### Teknik Özellikler

ÜRÜN KODU	ANMA AKIMI AC-3 (A)	ANMA GÜCÜ (kW) 50/60Hz	AC1 (A)	YARDIMCI KONTAK	K. ADEDİ	FİYAT
MK-910	9 A	4 kW	16 A	1NO	100	<b>12,90 \$</b>
MK-901	9 A	4 kW	16 A	1NC	100	<b>12,90 \$</b>

### Mini Kontaktör İçin Termik Röle



#### Teknik Özellikler

ÜRÜN KODU	TERMİK AYAR SAHASI (A)	ANMA AKIMI (A)	K. ADEDİ	FİYAT
UNTR-MK-6	4-6 A	6 A	100	<b>11,42 \$</b>

### Sessiz Kontaktör ( Aydınlatma Kontaktörü )



#### Teknik Özellikler

ÜRÜN KODU	ANMA AKIMI AC-3 (A)	KUTUP	YARDIMCI KONTAK	K. ADEDİ	FİYAT
ELX-2P-25A	25 A	2	2NO	100	<b>14,38 \$</b>

### Motor Koruma Şalteri



#### Teknik Özellikler

ÜRÜN KODU	ANMA AKIMI (A)	TERMİK AYAR (A)	AÇIKLAMA	K. ADEDİ	FİYAT
EMK-R-4	4.0 A	2,5-4 A	Motor Koruma Şalteri	50	<b>31,88 \$</b>
EMK-R-6,3	6.3 A	4-6,3 A	Motor Koruma Şalteri	50	<b>31,88 \$</b>
EMK-R-10	10 A	6-10 A	Motor Koruma Şalteri	50	<b>31,88 \$</b>
EMK-R-14	14 A	9-14 A	Motor Koruma Şalteri	50	<b>31,88 \$</b>
EMK-R-18	18 A	13-18 A	Motor Koruma Şalteri	50	<b>31,88 \$</b>
EMK-R-23	23 A	17-23 A	Motor Koruma Şalteri	50	<b>31,88 \$</b>
EMK-R-25	25 A	20-25 A	Motor Koruma Şalteri	50	<b>31,88 \$</b>
EMK-R-32	32A	24-32 A	Motor Koruma Şalteri	50	<b>31,88 \$</b>

### Darbe Akım Anahtarı



#### Teknik Özellikler

ÜRÜN KODU	ANMA AKIMI	K. ADEDİ	FİYAT
EDA-16	16 A	240	<b>14,30 \$</b>

## Boş Kumanda Kutuları

### ELX-BOX-1

1'li Boş Buton Kutusu

**FİYAT: 1,12 \$**

ÖLÇÜLER		
U	G	D
70	70	60



### ELX-BOX-1K

1'li Boş Buton Kutusu Korumalı

**FİYAT: 1,85 \$**

ÖLÇÜLER		
U	G	D
70	70	60



Boş Buton Kutuları  
( IP44 )



### Teknik Özellikler

ÜRÜN KODU	AÇIKLAMA	K. ADEDİ	FİYAT
LAY5 (DB2) Box1	1'li Boş Kumanda Kutusu	100	<b>1,12 \$</b>
LAY5 (DB2) Box2	2'li Boş Kumanda Kutusu	100	<b>2,25 \$</b>
LAY5 (DB2) Box3	3'lü Boş Kumanda Kutusu	75	<b>2,75 \$</b>
LAY5 (DB2) Box4	4'lü Boş Kumanda Kutusu	50	<b>3,30 \$</b>
LAY5 (DB2) Box5	5'li Boş Kumanda Kutusu	50	<b>4,18 \$</b>
LAY5 (DB2) Box6	6'li Boş Kumanda Kutusu	25	<b>4,50 \$</b>
LAY5 (DB2) Box7	7'li Boş Kumanda Kutusu	25	<b>4,83 \$</b>

## Kutulu Montajlı Ürünler

### ELX-BX1-AS

Acil Stop  
40 mm 1NC Kalıcı Kutu

FİYAT: 3,37 \$

ÖLÇÜLER		
U	G	D
70	70	60



### ELX-BX1-ASK

Acil Stop 40 mm 1NC  
Kalıcı Korumalı Kutu

FİYAT: 3,50 \$

ÖLÇÜLER		
U	G	D
70	70	60



### ELX-ALM-1

Kutulu Tekli Alarm Butonu

FİYAT: 3,46 \$

ÖLÇÜLER		
U	G	D
70	70	60



### ELX-K

Buton Koruma Kapağı

FİYAT: 0,525 \$

ÖLÇÜLER		
U	G	D
54	47	35



## Kutulu Montajlı Ürünler

### ELX-PAS-1

1'li Alarm Seti

**FİYAT: 7,00 \$**

ÖLÇÜLER		
U	G	D
120	70	60

- \* 9 V Pili 120db
- \* 6 Ton Siren



### ELX-BYP-B-24 VDC

Bypass Flaşör Sesli İkaz  
Bypass Buzzer

**FİYAT: 4,05 \$**

ÖLÇÜLER		
U	G	D
70	70	60



### ELX-KDRR-EG61

Kuyu Dışından  
Revizyon Reset Anahtar

**FİYAT: 4,50 \$**

ÖLÇÜLER		
U	G	D
70	70	60



### ELX-KAB-EA21

Kuyu Aydınlatma Butonu

**FİYAT: 3,46 \$**

ÖLÇÜLER		
U	G	D
70	70	60



## Kumanda Kutuları

### ELX-BX5-4

4'lü Revizyon Kutusu

FİYAT: 10,00 \$

ÖLÇÜLER		
U	G	D
190	65	70



### ELX-BX5-5

5'li Revizyon Kutusu  
Ortası Mavi

FİYAT: 11,05 \$

ÖLÇÜLER		
U	G	D
190	65	70



### ELX-BX6-5P

6'lı Revizyon Kutusu Ortası Boş,  
Alarm, Buzzer ve Prizli

FİYAT: 14,50 \$

ÖLÇÜLER		
U	G	D
300	80	70



### ELX-BX6-6

6'lı Revizyon Kutusu

FİYAT: 15,00 \$

ÖLÇÜLER		
U	G	D
300	80	70



\* ÜRÜNLERİMİZ MIKNATIS TABANLIDIR.

## Kumanda Kutuları

### ELX-ELP-RK

Prizli Revizyon Kutusu

**FİYAT: 10 \$**

ÖLÇÜLER		
U	G	D
170	80	70



\* ÜRÜNLERİMİZ MIKNATIS TABANLIDIR.

### ELX-EL3BYLS-RK

3 Kademe By Pass'lı  
Ledli Sinyalli Revizyon Kutusu

**FİYAT: 15,00 \$**

ÖLÇÜLER		
U	G	D
170	80	70



### ELX-EL3B-PLS-RK

3 Kademe By Pass'lı Prizli,  
Ledli Sinyalli Revizyon Kutusu

**FİYAT: 17,47 \$**

ÖLÇÜLER		
U	G	D
170	80	70



### ELX-ELK5

5'li Revizyon Kutusu  
İki Korumalı

**FİYAT: 13,00 \$**

ÖLÇÜLER		
U	G	D
170	80	70



\* ÜRÜNLERİMİZ MIKNATIS TABANLIDIR.

### ELX-EL3BY-RK

3 Kademe By Paslı  
Kuyu Aydınlatma Kutusu

**FİYAT SORUNUZ**

ÖLÇÜLER		
U	G	D
130	95	75



## Kumanda Kutuları

### ELX-ELK4

4'lü Revizyon Kutusu  
İki Korumalı

FİYAT: 11,25 \$

ÖLÇÜLER		
U	G	D
170	80	70

\* ÜRÜNÜMÜZ  
MIKNATIS  
TABANLIDIR.



### ELX-BX-7K

7'li El Kumanda Kuyu Dibi

FİYAT: 17,90 \$

ÖLÇÜLER		
U	G	D
300	70	70



\* ÜRÜNÜMÜZ MIKNATIS TABANLIDIR.

### ELX-BX-7P

7'li El Kumanda  
Prizli, Buzzerli Revizyon

FİYAT: 19,50 \$

ÖLÇÜLER		
U	G	D
300	70	70



\* ÜRÜNÜMÜZ MIKNATIS TABANLIDIR.

### ELX-KY-10

10'lu Kuyu Dibi Kutusu

FİYAT: 21,10 \$

ÖLÇÜLER		
U	G	D
235	130	110





## Kumanda Kutuları

### ELX-BX6-6N

6'lı Revizyon Kutusu  
Yeni Tip

**FİYAT: 15,90 \$**

ÖLÇÜLER		
U	G	D
200	70	70



### ELX-AKDMİ-7

Asansör Kuyu Dibi Kutusu

**FİYAT: 21,10 \$**

ÖLÇÜLER		
U	G	D
200	130	100



### ELX-2MSK-K5

5'li Revizyon Kutusu  
2M Silikon Kılıflı Buton, 2 Korumalı

**YENİ ÜRÜN**

**FİYAT: Sorunuz**

ÖLÇÜLER		
U	G	D
170	80	70



## Boy Fotoseli

### EL-MAX

Ultimate Boy Fotoseli

- 192 Işın
- Çapraz Tarama
- Dayanıklı Kablo
- Soketli Kablo Bağlantısı
- Uluslararası Standartlara Uygunluk
- **64 Adet Kızıl Ötesi Led**  
64 pieces infrared led
- **Çapraz tarama ile 192 ışın**  
192 beams with the cross scan
- **Dayanıklı malzeme soketli kablolar**  
Durable components, cables with sockets
- **10 mm. - 1950 mm. arası algılama boyutu**  
Sensation dimension between 10 mm. - 1950 mm.
- **4000 mm. den etkin algı özelliği**  
Sensation distance to 4000 mm.



PANORAMİK ASANSÖRLERDE  
%100 ÇALIŞMA  
PERFORMANSI

- **-15 °C + 55 °C sıcaklık arası çalışabilme**  
Working between -15 °C, + 55 °C
- **AC220V- DC24V1A Kontrol merkezi**  
AC220V - DC24V1A Control unit
- **1995 mm. boy x 11,5 mm. genişlik x 24 mm. derinlik**  
1995 mm. height x 11,5 mm. width x 24 mm. depth
- **Uluslararası standartlara uygunluk**  
International standards available

## Kumanda Kutuları

### ELX-ELK6 BYPASLI

5 Butonlu Sinyalli Revizyon



### ELX-BX6-6M

6lı Revizyon Kutusu Metal



Yeni Ürün

## Asansör Kumanda Sistemi ve Kuyu Bileşenleri

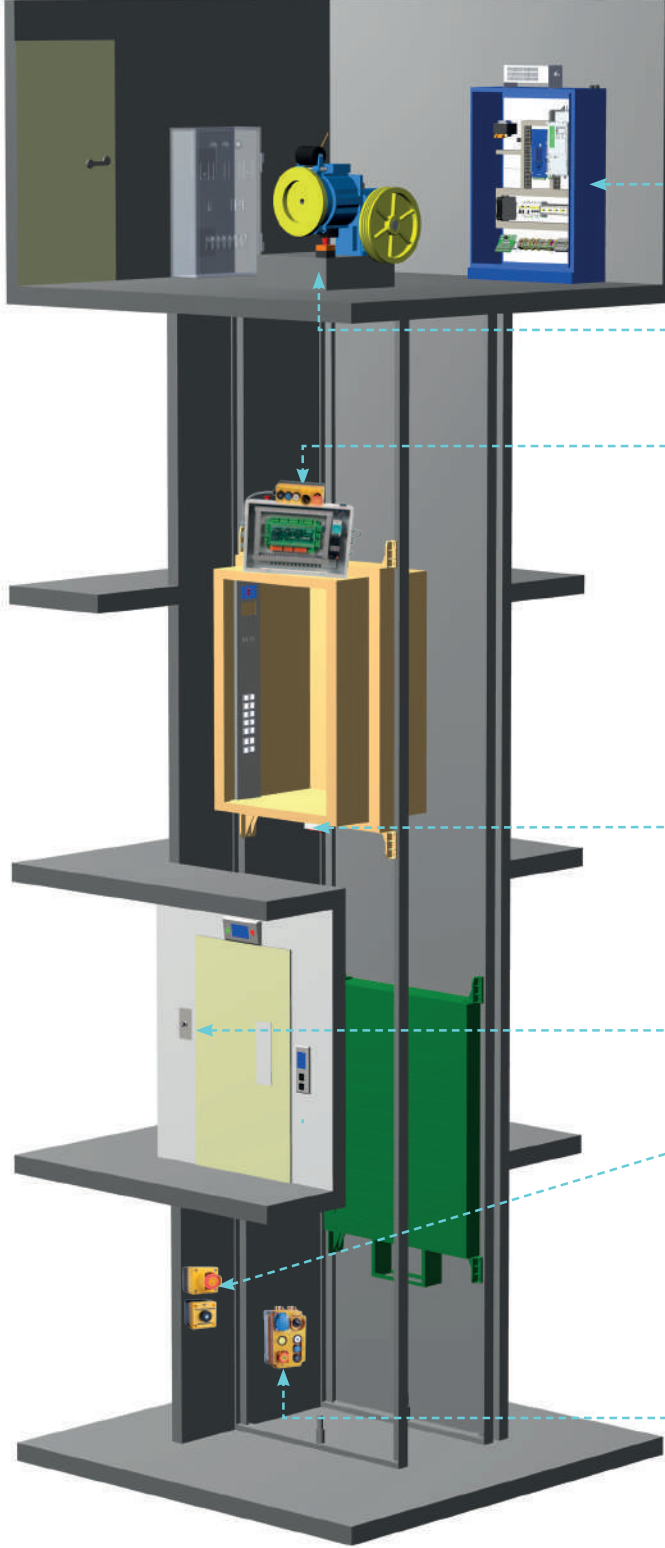

4'lü El Terminali  
ELX-BX5-4

**Kumanda Panosu**  
Control Panel



**Durdurma Anahtarı**  
Emergency Stop



**Kabin Üzeri Revizyon Seti**  
Car-Roof Inspection Box

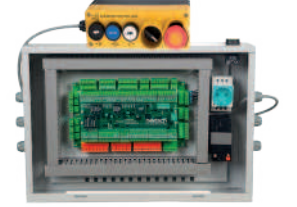

5'li El Terminali  
ELX-BX5-5

**Bypass Tertibat Sireni**  
Bypass Siren



**Reset Anahtarı**  
Electrical Reset Switch



**Durdurma ve Kuyu Ayd. Butonu**  
Emergency Stop and Shaft  
Lighting Button Box



**Muayene Kumanda İstasyonu**  
Inspection Control Station  
(Pit)



## Asansör Panosu EMC Filtre

### ELX-ASP

Asansör Panosu

- \* Asansör Panosu EL-MAX
- \* Asansör Panosu OAG
- \* Asansör Panosu HİMEL
- \* Asansör Panosu GENERAL
- \* Asansör Panosu MAKEL
- \* Asansör Panosu SCHNEIDER

**PANOLARIMIZ  
6x40 PAKO  
ŞALTERLİDİR.**

**FİYAT SORUNUZ**



### ELX-30-EMC

EMC Filtre 30 Amper

**FİYAT SORUNUZ**



Çalışma Voltajı : 400V  
Çalışma Frekansı : 0 - 50 Hz  
Çalışma Akımı : 30A  
Çalışma Sıcaklığı : -20 C / +80 C

### ELX-FD

Frenleme Direnci

**FİYAT SORUNUZ**

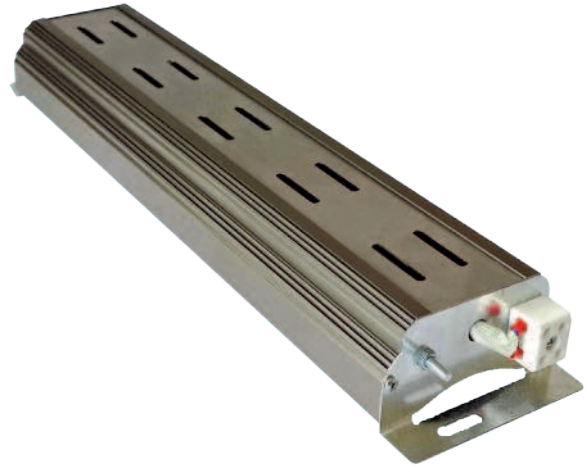

## Deprem Sensörü Duman Dedektörü

### ELX-DS

Deprem Sensörü

#### FİYAT SORUNUZ



### ELX-DD-12

Duman Dedektörü  
12 Volt DC

#### FİYAT SORUNUZ



### ELX-DD-24

Duman Dedektörü  
24 Volt DC

#### FİYAT SORUNUZ



80.  
Yil



since 1943  
**eL-max**

[www.el-max.com.tr](http://www.el-max.com.tr)



[www.ozbekenerji.com.tr](http://www.ozbekenerji.com.tr)

[www.ozbekenerji.com.tr](http://www.ozbekenerji.com.tr)

## Asansör Grubu Malzemeleri

### ELX-LED-5-SNB

5W Hareketli Spot Armatür

#### FİYAT SORUNUZ



5 W Saten Nikel Gövde  
Beyaz Işık, Hareketli Spot

### ELX-LTFA

T5 Anahtarlı Led Bant Armatür **KABLOLU**

#### FİYAT SORUNUZ



AÇIKLAMA	FİYAT
6 W Anahtarlı Led Lamba	Fiyat Sorunuz
10 W Anahtarlı Led Lamba	Fiyat Sorunuz
12 W Anahtarlı Led Lamba	Fiyat Sorunuz
16 W Anahtarlı Led Lamba	Fiyat Sorunuz

### ELX-LTFA

Ledli Yatay Bant Armatür

#### FİYAT SORUNUZ



AÇIKLAMA	FİYAT
18 W Yatay Led Lamba	Fiyat Sorunuz
36 W Yatay Led Lamba	Fiyat Sorunuz

### ELX-LEA

Nemliyer Ledli Etanj Armatür

#### FİYAT SORUNUZ

IP 65  
30.000 Saat Ömür  
6500 K



AÇIKLAMA	FİYAT
18 w Etanj	Fiyat Sorunuz
36 w Etanj	Fiyat Sorunuz

## Asansör Grubu Malzemeleri

### KLEMENS AKSESUAR

#### FİYAT SORUNUZ

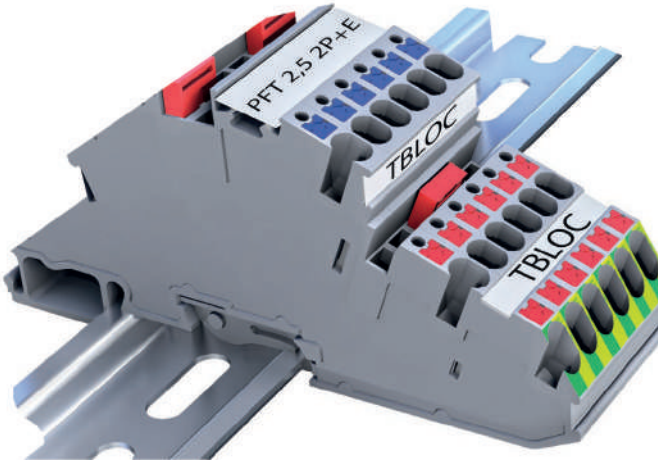

### OTOMAT RAYI

Ray Taşıyıcı

#### FİYAT SORUNUZ



### ELX-STA

Mono Stabil/ Bi Stabil / Silver Mono Stabil

#### FİYAT SORUNUZ



### NÜVE

#### FİYAT SORUNUZ





## Asansör Grubu Malzemeleri

### ELX-0.80NYA

0.80 NYA Kablo

**FİYAT SORUNUZ**



### ELX-DT13

DT 13 Dijital Kablo - Telefon Kabloları

**FİYAT SORUNUZ**

## Asansör Grubu Malzemeleri

### RAYA Montaj Pano Prizi

**FİYAT SORUNUZ**



### TRAFO Asansör Güç Trafosu

**FİYAT SORUNUZ**



### 3x25 Amper Makina Prizi

**FİYAT SORUNUZ**



### 1x16 Amper Pano Prizi

**FİYAT SORUNUZ**



## Asansör Grubu Malzemeleri

### ELX-PS

Pako Şalter

**FİYAT SORUNUZ**



### BY-PASS

Şalter

**FİYAT SORUNUZ**



### Ray Montaj Pako Şalter

**FİYAT SORUNUZ**

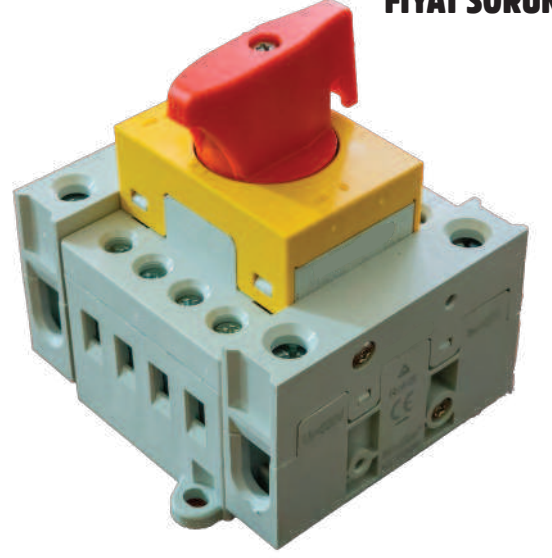

### NEMLİYER GRUBU

**FİYAT SORUNUZ**



### ELX-BKA

Beta Kafesli Aplik

**FİYAT SORUNUZ**



### ELX-LED

E-27 Led Ampul

**FİYAT SORUNUZ**



**AÇIKLAMA**  
10 W E-27 Led Ampul

**FİYAT**  
Fiyat Sorunuz

## Asansör Grubu Malzemeleri

### PANO SİRALI

1-2-3-4 No

**FİYAT: SORUNUZ**



### PLASTİK SİRAL

14-18 mm

**FİYAT: SORUNUZ**



### KLEMENS

7 Delikli Topraklama Klemensi

**FİYAT: SORUNUZ**



## Kablo Kanalları

### DELİKLİ KABLO KANALLARI

#### FİYAT: SORUNUZ

25 x 40 mm  
25 x 60 mm  
40 x 40 mm  
40 x 60 mm  
60 x 60 mm  
60 x 80 mm

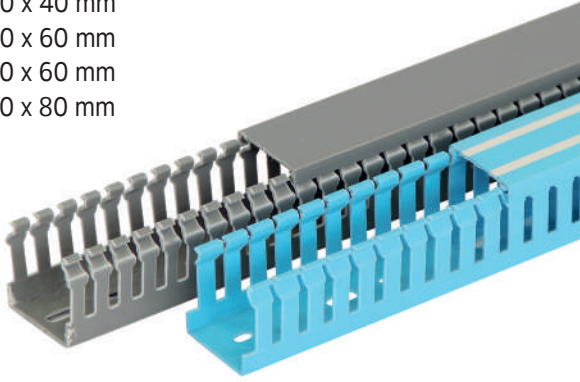

### KAPALI KABLO KANALLARI

#### FİYAT: SORUNUZ

16 x 16 mm  
25 x 16 mm  
25 x 25 mm  
40 x 60 mm  
60 x 40 mm  
10 x 40 mm  
100 x 60 mm



### SAÇ KABLO KANALLARI

#### FİYAT: SORUNUZ

50 x 40 mm  
100 x 40 mm  
100 x 60 mm



### KANAL KROŞESİ

#### FİYAT: SORUNUZ

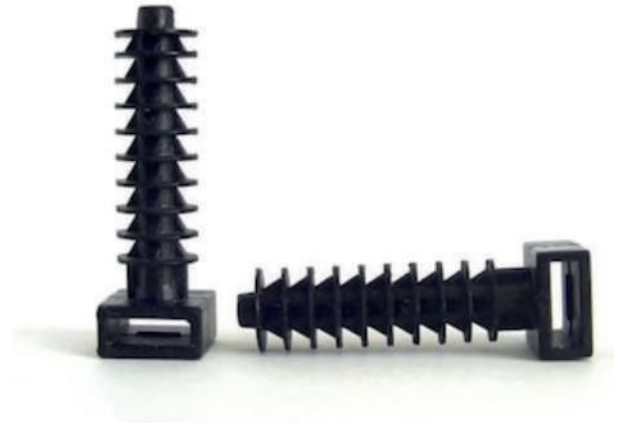

## Buzzer - Aküler - Köprü Diyot Miknatıs Işıklı Mini Anahtar

### Ø 30mm Ses'li Buzzer (105 dB)



#### Teknik Özellikler

ÜRÜN KODU	RENK	VOLTAJ	K. ADEDİ	AÇIKLAMA	FİYAT
FM - 220AA 901AF	■ Siyah	110-220V. AC	20	Ø 30mm Tek Ses İkazlı	<b>11 \$</b>
FM - 220AA 907AF	■ Siyah	110-220V. AC	20	Ø 30mm Çift Ses İkazlı	<b>12,5 \$</b>

Not: Tek Ses İkazlılar Kesik Tonlu, Çift Ses İkazlar Kesik ve Sürekli Tonludur.

### Mıknatıslar



#### Teknik Özellikler

ÜRÜN KODU	K. ADEDİ	AÇIKLAMA	FİYAT
22 x 7	1500	22 mm Çap, 7 mm Yükseklik Kırmızı Boyalı Yuvarlak Mıknatıs	<b>0,125 \$</b>
10 cm Şerit Mıknatıs	360	20 mm en, 8 mm Yükseklik, Şerit Mıknatıs	<b>0,69 \$</b>
30 cm Şerit Mıknatıs	120	20 mm en , 8 mm Yükseklik, Şerit Mıknatıs	<b>1,69 \$</b>

### Aküler / AGM Kuru Tip Akü



#### Teknik Özellikler

ÜRÜN KODU	K. ADEDİ	AÇIKLAMA	FİYAT
EL 12 1.3	20	12V 1.3Ah/20hr	<b>Sorunuz</b>
EL 12 7	8	12V 7Ah/20hr	<b>Sorunuz</b>

### Köprü Diyot



#### Teknik Özellikler

ÜRÜN KODU	AKIM	AÇIKLAMA	K. ADEDİ	FİYAT
KD-35	35 AMPER	Köprü Diyot	50	<b>1,28 \$</b>
KD-50	50 AMPER	Köprü Diyot	50	<b>2,10 \$</b>

### Mini Anahtarlar

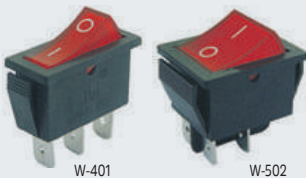

#### Teknik Özellikler

#### FİYAT SORUNUZ

ÜRÜN KODU	AYAK SAYISI	YÜK GERİLİMİ	AÇIKLAMA	FONKSİYON	ÖLÇÜ
W-401	3 Pin	6 A / 250 VAC	Işıklı Dar Tip	ON-OFF	28,5 x 10,5
W-502	4 Pin	6 A / 250 VAC	Işıklı Geniş Tip	ON-OFF	Işıklı Geniş Tip

## 24 V Güç Kaynakları



### 15 W Güç Kaynağı

**FİYAT: 10,84 \$**

ÜRÜN KODU	ELX-TR-24-15
GÜÇ	15 W
AÇIKLAMA	Güç Kaynağı
AKIM	0.6 A
KUTU ADEDİ	400 Adet



### 25 W Güç Kaynağı

**FİYAT: 18,00 \$**

ÜRÜN KODU	ELX-TR-24-25
GÜÇ	25 W
AÇIKLAMA	Güç Kaynağı
AKIM	1.0 A
KUTU ADEDİ	200 Adet

### 60 W Güç Kaynağı

**FİYAT: 21,00 \$**

ÜRÜN KODU	ELX-TR-24-60
GÜÇ	60 W
AÇIKLAMA	Güç Kaynağı
AKIM	2.5 A
KUTU ADEDİ	100 Adet

IP:20  
24 V

### 120 W Güç Kaynağı

**FİYAT: 28,00 \$**

ÜRÜN KODU	ELX-TR-24-120
GÜÇ	120 W
AÇIKLAMA	Güç Kaynağı
AKIM	5 A
KUTU ADEDİ	50 Adet

### 150 W Güç Kaynağı

**FİYAT: 42,0 \$**

ÜRÜN KODU	ELX-TR-24-150
GÜÇ	150 W
AÇIKLAMA	Güç Kaynağı
AKIM	6.25 A
KUTU ADEDİ	50 Adet

### 200 W Güç Kaynağı

**FİYAT: 48,0 \$**

ÜRÜN KODU	ELX-TR-24-200
GÜÇ	200 W
AÇIKLAMA	Güç Kaynağı
AKIM	8.5 A
KUTU ADEDİ	50 Adet

### 250 W Güç Kaynağı

**FİYAT: 49,50 \$**

ÜRÜN KODU	ELX-TR-24-250
GÜÇ	250 W
AÇIKLAMA	Güç Kaynağı
AKIM	10 A
KUTU ADEDİ	20 Adet

### 350 W Güç Kaynağı

**FİYAT: 71,50 \$**

ÜRÜN KODU	ELX-TR-24-350
GÜÇ	350 W
AÇIKLAMA	Güç Kaynağı
AKIM	15 A
KUTU ADEDİ	20 Adet

### 500 W Güç Kaynağı

**FİYAT: 82,50 \$**

ÜRÜN KODU	ELX-TR-24-500
GÜÇ	500 W
AÇIKLAMA	Güç Kaynağı
AKIM	20 A
KUTU ADEDİ	20 Adet

## LAY 5 Plastik Buton Serisi



### Yaylı Butonlar 250 VAC/3A (IP44)



#### Teknik Özellikler

ÜRÜN KODU	RENK	KONTAK	K. ADEDİ	AÇIKLAMA	FİYAT
LAY5 (DB2) EA31	Yeşil	1 NO	20	Q22mm Start Buton	<b>1,10 \$</b>
LAY5 (DB2) EA42	Kırmızı	1 NC	20	Q22mm Stop Buton	<b>1,10 \$</b>
LAY5 (DB2) EA51	Sarı	1 NO	20	Q22mm Start Buton	<b>1,10 \$</b>
LAY5 (DB2) EA21	Siyah	1 NO	20	Q22mm Start Buton	<b>1,10 \$</b>

### İşaretili Yaylı Butonlar 250 VAC/3A (IP44)



#### Teknik Özellikler

ÜRÜN KODU	KONTAK	K. ADEDİ	AÇIKLAMA	FİYAT
LAY5 (DB2) EA21	1 NO	20	Q22mm Siyah Tabanlı, Beyaz Lamba	<b>1,20 \$</b>
LAY5 (DB2) EA51	1 NO	20	Q22mm Sarı Tabanlı, Siyah Zilli	<b>1,20 \$</b>
LAY5 (DB2) EA61	1 NO	20	Q22mm Mavi Tabanlı, Çift Yönlü Ok	<b>1,20 \$</b>
LAY5 (DB2) EA3341	1 NO	20	Q22mm Beyaz Tabanlı, Siyah Ok	<b>1,20 \$</b>
LAY5 (DB2) EA3351	1 NO	20	Q22mm Siyah Tabanlı, Beyaz Ok	<b>1,20 \$</b>

### Mandal Butonlar 250 VAC/3A (IP44)



#### Teknik Özellikler

ÜRÜN KODU	KONUM	KONTAK	K. ADEDİ	AÇIKLAMA	FİYAT
LAY5 (DB2) ED21	0-1 Kalıcı	1 NO	20	Q22mm Kalıcı Mandal Buton	<b>1,25 \$</b>
LAY5 (DB2) ED41	0-(1)Kayıcı	1 NO	20	Q22mm Kayıcı Mandal Buton	<b>1,45\$</b>
LAY5 (DB2) ED33	1-0-2 Kalıcı	1 NO+1NO	20	Q22mm Kalıcı Mandal Buton	<b>2,60 \$</b>
LAY5 (DB2) ED53	1-0-2 Kayıcı	1 NO+1NO	20	Q22mm Kayıcı Mandal Buton	<b>2,70 \$</b>



## LAY 5 Plastik Buton Serisi



### 40mm İkiz Butonlar 250 VAC/3A (IP44)

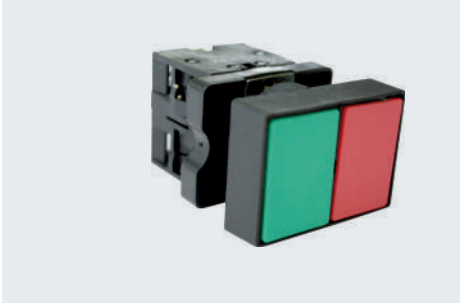

#### Teknik Özellikler

ÜRÜN KODU	RENK	KONTAK	K. ADEDİ	AÇIKLAMA	FİYAT
LAY5 (DB2) EL8325	Yeşil - Kırmızı	1 NO+1 NC	20	Q22mm İkiz Buton	<b>3,70 \$</b>

### 40mm Mantar Butonlar 250 VAC/3A (IP44)



#### Teknik Özellikler

ÜRÜN KODU	RENK	KONTAK	K. ADEDİ	AÇIKLAMA	FİYAT
LAY5 (DB2) ES542	■ Kırmızı	1 NC	20	Q40mm Acil Stop Mantar	<b>1,76 \$</b>
LAY5 (DB2) ES442	■ Kırmızı	1 NC	20	Q30mm Acil Stop Mantar	<b>1,76 \$</b>
LAY5 (DB2) ES142	■ Kırmızı	1 NC	20	Q40mm Anahtarlı Buton	<b>3,94 \$</b>
LAY5 (DB2) EC42	■ Kırmızı	1 NC	20	Q40mm Acil Stop Mantar	<b>1,80 \$</b>
LAY5 (DB2) EC31	■ Yeşil	1 NO	20	Q40mm Acil Stop Mantar	<b>1,80 \$</b>

### Anahtarlı Buton



#### Teknik Özellikler

ÜRÜN KODU	KONUM	KONTAK	K. ADEDİ	AÇIKLAMA	FİYAT
LAY5 (DB2) EG41	Kalıcı	1 NO	20	Q22mm 0-1 Kalıcı	<b>3,90 \$</b>
LAY5 (DB2) EG61	Kayıcı	1 NO	20	Q22mm 0-1 Kayıcı	<b>3,90 \$</b>
LAY5 (DB2) EG73	1-0-2 Kayıcı	2 NO	20	Q22mm 1-0-2 Kayıcı	<b>4,40 \$</b>

## LAY 5 Metal Buton Serisi



### Yaylı Butonlar 250 VAC/3A (IP44)

Teknik Özellikler



ÜRÜN KODU	RENK	KONTAK	K. ADEDİ	AÇIKLAMA	FİYAT
LAY5 (DB2) BA31	Yeşil	1 NO	20	Q22mm Start Buton	<b>2,11 \$</b>
LAY5 (DB2) BA42	Kırmızı	1 NC	20	Q22mm Stop Buton	<b>2,11 \$</b>
LAY5 (DB2) BA51	Sarı	1 NO	20	Q22mm Start Buton	<b>2,11 \$</b>
LAY5 (DB2) BA21	Siyah	1 NO	20	Q22mm Start Buton	<b>2,11 \$</b>

### İşaretili Yaylı Butonlar 250 VAC/3A (IP44)

Teknik Özellikler



ÜRÜN KODU	RENK	KONTAK	K. ADEDİ	AÇIKLAMA	FİYAT
LAY5 (DB2) BA3341	Beyaz	1 NO	20	Q22mm Start Buton	<b>2,27 \$</b>
LAY5 (DB2) BA3351	Siyah	1 NO	20	Q22mm Start Buton	<b>2,27 \$</b>

### 40mm Mantar Butonlar 250 VAC/3A (IP44)

Teknik Özellikler



ÜRÜN KODU	RENK	KONTAK	K. ADEDİ	AÇIKLAMA	FİYAT
LAY5 (DB2) BS542	Kırmızı	1 NC	20	Q40mm Acil Stop Mantar Kalıcı	<b>2,82 \$</b>
LAY5 (DB2) BC21	Siyah	1 NO	20	Q40mm Yaylı Mantar Buton Kayıcı	<b>2,82 \$</b>

### 40mm İkiz Butonlar 250 VAC/3A (IP44)

Teknik Özellikler



ÜRÜN KODU	RENK	KONTAK	K. ADEDİ	AÇIKLAMA	FİYAT
LAY5 (DB2) BL8325	Kır-Yeşil	1 NO+1NC	20	Q22mm İkiz Buton	<b>4,45 \$</b>

## LAY 5 Metal Buton Serisi / Joystick Kontrol Yedek Kontak / Potansiyometre

Kalıcı Mandal Butonlar 250 VAC/3A (IP44)

Teknik Özellikler

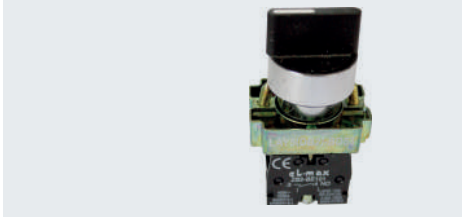

ÜRÜN KODU	KONUM	KONTAK	K. ADEDİ	AÇIKLAMA	FİYAT
LAY5 (DB2) BD21	0-1 Kalıcı	1 NO	20	Q22mm Kalıcı Mandal Buton	<b>2,43 \$</b>
LAY5 (DB2) BD33	1-0-2 Kalıcı	1NO + 1NO	20	Q22mm Kalıcı Mandal Buton	<b>3,10 \$</b>

Anahtarlı Buton

Teknik Özellikler

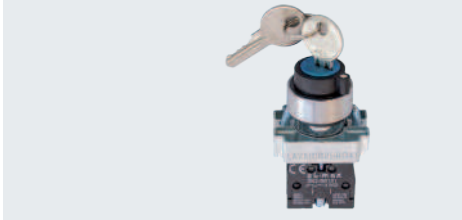

ÜRÜN KODU	KONUM	KONTAK	K. ADEDİ	AÇIKLAMA	FİYAT
LAY5 (DB2) BG41	0-1 Kalıcı	1 NO	20	Q22mm Anahtarlı Buton	<b>4,63 \$</b>

Joystick Kontrol

Teknik Özellikler



ÜRÜN KODU	RENK	KONTAK	K. ADEDİ	AÇIKLAMA	FİYAT
LAY5 (DB2) PA22	Gri-Siyah	2 N/O	10	Metal 2 Yönlü Yaylı	<b>18,60 \$</b>

Yedek Kontak Blok 250 VAC/3A (IP44)

Teknik Özellikler



ÜRÜN KODU	RENK	KONTAK	K. ADEDİ	AÇIKLAMA	FİYAT
LAY5 (DB2) BE101	Yeşil	1 NO	100	Yedek Kontak Blok	<b>0,57 \$</b>
LAY5 (DB2) BE102	Kırmızı	1 NC	100	Yedek Kontak Blok	<b>0,57 \$</b>

Ø 22mm Potansiyometre Tek Tur

Teknik Özellikler



ÜRÜN KODU	KONTAK	K. ADEDİ	AÇIKLAMA	FİYAT
ELX PT 5K	5K (Tek Tur)	10	Ø22mm Potansiyometre	<b>7,50 \$</b>
ELX PT 10K	10K (Tek Tur)	10	Ø22mm Potansiyometre	<b>7,50 \$</b>

## ELX2M Plastik Buton Serisi

### Yaylı Butonlar Q22mm



#### Teknik Özellikler

ÜRÜN KODU	RENK	KONTAK	K. ADEDİ	AÇIKLAMA	FİYAT
ELX2M-10	■ Yeşil	1 NO	10	Yaylı Buton	<b>2,30 \$</b>
ELX2M-01	■ Kırmızı	1 NC	10	Yaylı Buton	<b>2,30 \$</b>
ELX2M-11	■ Sarı	1 NO	10	Yaylı Buton	<b>2,30 \$</b>
ELX2M-21	■ Mavi	1 NO	10	Yaylı Buton	<b>2,30 \$</b>
ELX2M-31	□ Beyaz	1 NO	10	Yaylı Buton	<b>2,30 \$</b>
ELX2M-41	■ Siyah	1 NO	10	Yaylı Buton	<b>2,30 \$</b>

### İşaretli Yaylı Butonlar Q22mm



#### Teknik Özellikler

ÜRÜN KODU	KONTAK	K. ADEDİ	AÇIKLAMA	FİYAT
ELX2M-1011	1 NO	10	İşaretli Yaylı Buton 	<b>2,60 \$</b>
ELX2M-1012	1 NC	10	İşaretli Yaylı Buton 	<b>2,60 \$</b>
ELX2M-1013	1 NO	10	İşaretli Yaylı Buton 	<b>2,60 \$</b>
ELX2M-1014	1 NO	10	İşaretli Yaylı Buton 	<b>2,60 \$</b>

### İşikli Yaylı Butonlar Q22mm



#### Teknik Özellikler

ÜRÜN KODU	RENK	KONTAK	K. ADEDİ	AÇIKLAMA	FİYAT
ELX2M-10L	■ Yeşil	1 NO	10	İşikli Yaylı Buton 220V AC/DC	<b>4,18 \$</b>
ELX2M-01L	■ Kırmızı	1 NC	10	İşikli Yaylı Buton 220V AC/DC	<b>4,18 \$</b>
ELX2M-11L	■ Sarı	1 NO	10	İşikli Yaylı Buton 220V AC/DC	<b>4,18 \$</b>
ELX2M-21L	■ Mavi	1 NO	10	İşikli Yaylı Buton 220V AC/DC	<b>4,18 \$</b>
ELX2M-31L	□ Beyaz	1 NO	10	İşikli Yaylı Buton 220V AC/DC	<b>4,18 \$</b>
ELX2M-10L-110	■ Yeşil	1 NO	10	İşikli Yaylı Buton 110V AC/DC	<b>4,18 \$</b>
ELX2M-01L-110	■ Kırmızı	1NC	10	İşikli Yaylı Buton 110V AC/DC	<b>4,18 \$</b>
ELX2M-11L-110	■ Sarı	1 NO	10	İşikli Yaylı Buton 110V AC/DC	<b>4,18 \$</b>
ELX2M-21L-110	■ Mavi	1 NO	10	İşikli Yaylı Buton 110V AC/DC	<b>4,18 \$</b>
ELX2M-31L-110	□ Beyaz	1 NO	10	İşikli Yaylı Buton 110V AC/DC	<b>4,18 \$</b>
ELX2M-10L-24	■ Yeşil	1 NO	10	İşikli Yaylı Buton 24V AC/DC	<b>4,18 \$</b>
ELX2M-01L-24	■ Kırmızı	1NC	10	İşikli Yaylı Buton 24V AC/DC	<b>4,18 \$</b>
ELX2M-11L-24	■ Sarı	1 NO	10	İşikli Yaylı Buton 24V AC/DC	<b>4,18 \$</b>
ELX2M-21L-24	■ Mavi	1 NO	10	İşikli Yaylı Buton 24V AC/DC	<b>4,18 \$</b>
ELX2M-31L-24	□ Beyaz	1 NO	10	İşikli Yaylı Buton 24V AC/DC	<b>4,18 \$</b>

## ELX2M Plastik Buton Serisi

### Kalıcı Mandal Butonlar Q22mm



#### Teknik Özellikler

ÜRÜN KODU	KONTAK	K. ADEDİ	AÇIKLAMA	FİYAT
ELX2M-10KL	1 NO	10	0 - 1 Mandal Buton	<b>2,60 \$</b>
ELX2M-20KL	2 NO	10	1 - 0 - 2 Mandal Buton	<b>3,45 \$</b>

### Kayıcı Mandal Butonlar Q22mm



#### Teknik Özellikler

ÜRÜN KODU	KONTAK	K. ADEDİ	AÇIKLAMA	FİYAT
ELX2M-10KY	1 NO	10	0 - 1 Mandal Buton	<b>3,00 \$</b>
ELX2M-20KY	2 NO	10	1 - 0 - 2 Mandal Buton	<b>3,85 \$</b>

### Anahtarlı Kalıcı Butonlar Q22mm



#### Teknik Özellikler

ÜRÜN KODU	KONTAK	K. ADEDİ	AÇIKLAMA	FİYAT
ELX2M-10AN	1 NO	10	0 - 1 Anahtarlı Buton	<b>3,85 \$</b>
ELX2M-20AN	2 NO	10	1 - 0 - 2 Anahtarlı Buton	<b>4,78 \$</b>

## ELX2M Plastik Buton Serisi Buton Serisi Aksesuarları

### Işıklı Kalıcı Mandal Butonlar Q22mm



#### Teknik Özellikler

ÜRÜN KODU	RENK	KONTAK	K. ADEDİ	AÇIKLAMA	FİYAT
ELX2M-10LK	Yeşil	1 NO	10	0-1 Işıklı MANDAL Buton 220V AC/DC	<b>4,20 \$</b>
ELX2M-01LK	Kırmızı	1 NC	10	0-1 Işıklı MANDAL Buton 220V AC/DC	<b>4,20 \$</b>
ELX2M-11LK	Sarı	1 NO	10	0-1 Işıklı MANDAL Buton 220V AC/DC	<b>4,20 \$</b>
ELX2M-10LK-110	Yeşil	1 NO	10	0-1 Işıklı MANDAL Buton 110V AC/DC	<b>4,20 \$</b>
ELX2M-01LK-110	Kırmızı	1 NC	10	0-1 Işıklı MANDAL Buton 110V AC/DC	<b>4,20 \$</b>
ELX2M-11LK-110	Sarı	1 NO	10	0-1 Işıklı MANDAL Buton 110V AC/DC	<b>4,20 \$</b>
ELX2M-10LK-24	Yeşil	1 NO	10	0-1 Işıklı MANDAL Buton 24V AC/DC	<b>4,20 \$</b>
ELX2M-01LK-24	Kırmızı	1 NC	10	0-1 Işıklı MANDAL Buton 24V AC/DC	<b>4,20 \$</b>
ELX2M-11LK-24	Sarı	1 NO	10	0-1 Işıklı MANDAL Buton 24V AC/DC	<b>4,20 \$</b>
ELX2M-20LK	Yeşil	2 NO	10	1-0-2 Işıklı MANDAL Buton 220V AC/DC	<b>5,28 \$</b>
ELX2M-02LK	Kırmızı	2 NC	10	1-0-2 Işıklı MANDAL Buton 220V AC/DC	<b>5,28 \$</b>
ELX2M-21LK	Sarı	2 NO	10	1-0-2 Işıklı MANDAL Buton 220V AC/DC	<b>5,28 \$</b>
ELX2M-20LK-110	Yeşil	2 NO	10	1-0-2 Işıklı MANDAL Buton 110V AC/DC	<b>5,28 \$</b>
ELX2M-02LK-110	Kırmızı	2 NC	10	1-0-2 Işıklı MANDAL Buton 110V AC/DC	<b>5,28 \$</b>
ELX2M-21LK-110	Sarı	2 NO	10	1-0-2 Işıklı MANDAL Buton 110V AC/DC	<b>5,28 \$</b>
ELX2M-20LK-24	Yeşil	2 NO	10	1-0-2 Işıklı MANDAL Buton 24V AC/DC	<b>5,28 \$</b>
ELX2M-02LK-24	Kırmızı	2 NC	10	1-0-2 Işıklı MANDAL Buton 24V AC/DC	<b>5,28 \$</b>
ELX2M-21LK-24	Sarı	2 NO	10	1-0-2 Işıklı MANDAL Buton 24V AC/DC	<b>5,28 \$</b>

### Kalıcı Mantar Butonlar Q22mm



#### Teknik Özellikler

ÜRÜN KODU	KONTAK	K. ADEDİ	AÇIKLAMA	FİYAT
ELX2M-01AS	1 NC	10	Stop Mantar Buton	<b>2,97 \$</b>

### İkiz Butonlar Q22mm

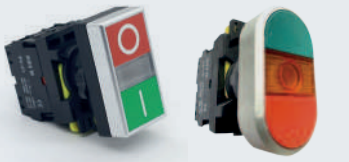

#### Teknik Özellikler

ÜRÜN KODU	KONTAK	K. ADEDİ	AÇIKLAMA	FİYAT
ELX2M-11TBR	1 NO + 1 NC	10	Start	<b>4,30 \$</b>
ELX2M-11TBL	1 NO + 1 NC	10	Işıklı İkiz Buton 220V AC/DC	<b>5,70 \$</b>

### Buton Aksesuarları Q22mm



#### Teknik Özellikler

ÜRÜN KODU	KONTAK	K. ADEDİ	AÇIKLAMA	FİYAT
ELX2M-11A	1 NO	250	Start Kontak	<b>1,04 \$</b>
ELX2M-01A	1 NC	250	Stop Kontak	<b>1,04 \$</b>

## LAY5 Plastik Buton Serisi



### Plastik Yaylı Butonlar

Teknik Özellikler



ÜRÜN KODU	RENK	KONTAK	K. ADEDİ	AÇIKLAMA	FİYAT
LAY5-AA51 Zilli	■ Sarı	1 NO	10	Q22mm Start Buton	<b>2,70 \$</b>
LAY5-AA61 Oklu	■ Mavi	1 NO	10	Q22mm Start Buton	<b>2,70 \$</b>

### Plastik İşaretli Yaylı Butonlar

Teknik Özellikler



ÜRÜN KODU	RENK	KONTAK	K. ADEDİ	AÇIKLAMA	FİYAT
LAY5-AA3341	□ Beyaz	1 NO	10	Q22mm Start Buton	<b>2,70 \$</b>
LAY5-AA3351	■ Siyah	1 NO	10	Q22mm Start Buton	<b>2,70 \$</b>

### Plastik İkiz Butonlar

Teknik Özellikler

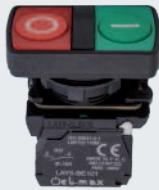

ÜRÜN KODU	RENK	KONTAK	K. ADEDİ	AÇIKLAMA	FİYAT
LAY5-AL8325	Kırmızı-Yeşil	1NO / 1NC	10	Ø 22 mm İkiz Butonlar	<b>6,30 \$</b>

### Plastik Kalıcı Mandal Butonlar

Teknik Özellikler



ÜRÜN KODU	KONUM	KONTAK	K. ADEDİ	AÇIKLAMA	FİYAT
LAY5-AD21	0 1 Kalıcı	1NO	10	Ø 22 mm Mandal Butonlar 3 Kontak Takılabilir	<b>3,20 \$</b>

## LAY5 Plastik Buton Serisi

### Plastik Ø 40 mm Mantar Acil Stop

Teknik Özellikler



ÜRÜN KODU	RENK	KONTAK	K. ADEDİ	AÇIKLAMA	FİYAT
LAY5-AS542	<span style="color: red;">■</span> Kırmızı	1NC	10	Ø 22 mm Mantar Butonlar	<b>4,30 \$</b>

### Plastik Anahtarlı Butonlar

Teknik Özellikler



ÜRÜN KODU	RENK	KONTAK	K. ADEDİ	AÇIKLAMA	FİYAT
LAY5-AG21	0 1 Kalıcı	1NO	10	Ø 22 mm Mantar Butonlar	<b>6,20 \$</b>

### Plastik Led'li Işıklı Yaylı Butonlar

Teknik Özellikler



ÜRÜN KODU	RENK	KONTAK	K. ADEDİ	AÇIKLAMA	FİYAT
LAY5-AW3375	Yeşil	1NO	10	Ø 22 mm Led 110-240 V AC	<b>5,96 \$</b>
LAY5-AW3575	Sarı	1NO	10	Ø 22 mm Led 110-240 V AC	<b>5,96 \$</b>
LAY5-AW3475	Kırmızı	1 NC	10	Ø 22 mm Led 110-240 V AC	<b>5,96 \$</b>

### Plastik Led'li Işıklı 0-1 Mandal

Teknik Özellikler



ÜRÜN KODU	RENK	KONTAK	K. ADEDİ	AÇIKLAMA	FİYAT
LAY5-AK-125L	Sarı	1NO+	10	Ø 22 mm 0-1 Kalıcı Led 220VAC	<b>8,00 \$</b>

### Plastik Led'li Işıklı 0-1-2 Mandal

Teknik Özellikler



ÜRÜN KODU	RENK	KONTAK	K. ADEDİ	AÇIKLAMA	FİYAT
LAY5-AK-323L	Yeşil	1NC/1NC	10	Ø 22 mm 1-0-2 Kalıcı Led 220VAC	<b>8,00 \$</b>

PLASTİK GÖVDELİ BUTONLAR PA66

ALEV YAYMAZ PLASTİK MALZEMEDEN ÜRETİLMEKTEDİR.



## Yedek Kontak Blok

Yedek Kontak Blok 250 VAC/3A (IP44)

Teknik Özellikler



ÜRÜN KODU	RENK	KONTAK	K. ADEDİ	AÇIKLAMA	FİYAT
LAY5 BE101	Yeşil	1 NO	100	Yedek Kontak Blok	<b>1,10 \$</b>
LAY5 BE102	Kırmızı	1 NC	100	Yedek Kontak Blok	<b>1,10 \$</b>

## Sirenler

Elektronik Sirenler Ø 50mm (120 dB)

Teknik Özellikler



ÜRÜN KODU	RENK	VOLTAJ	K. ADEDİ	AÇIKLAMA	FİYAT
ES -50 -12-24	■ Siyah	12-24V.AC/DC	8	Elektronik Siren Plastik Gövde	<b>5,30 \$</b>

## Buzzer ve Ledli Sinyal Lambaları

Led'li Buzzer Q22mm (90dB)

Teknik Özellikler



ÜRÜN KODU	RENK	VOLTAJ	K. ADEDİ	AÇIKLAMA	FİYAT
AD 16 - 22SM/R	Kırmızı	220V AC	10	Q22mm Led'li Buzzer	<b>3,10 \$</b>
AD 16 - 22SM/R	Kırmızı	24V AC/DC	10	Q22mm Led'li Buzzer	<b>3,10 \$</b>

Led'li Sinyal Q22MM 220/240V AC

Teknik Özellikler



ÜRÜN KODU	RENK	VOLTAJ	K. ADEDİ	AÇIKLAMA	FİYAT
AD 22 - 22DS/R	Kırmızı	230V AC	10	Q22mm Led'li Sinyal	<b>0,80 \$</b>
AD 22 - 22DS/G	Yeşil	230V AC	10	Q22mm Led'li Sinyal	<b>0,80 \$</b>
AD 22 - 22DS/Y	Sarı	230V AC	10	Q22mm Led'li Sinyal	<b>0,80 \$</b>
AD 22 - 22DS/B	Mavi	230V AC	10	Q22mm Led'li Sinyal	<b>1,19 \$</b>
AD 22 - 22DS/W	Beyaz	230V AC	10	Q22mm Led'li Sinyal	<b>1,19 \$</b>

Led'li Sinyal Q22MM 24VAC/DC

Teknik Özellikler



ÜRÜN KODU	RENK	VOLTAJ	K. ADEDİ	AÇIKLAMA	FİYAT
AD 22 - 22DS/R	Kırmızı	24V AC-DC	10	Q22mm Led'li Sinyal	<b>0,80 \$</b>
AD 22 - 22DS/G	Yeşil	24V AC-DC	10	Q22mm Led'li Sinyal	<b>0,80 \$</b>
AD 22 - 22DS/Y	Sarı	24V AC-DC	10	Q22mm Led'li Sinyal	<b>0,80 \$</b>
AD 22 - 22DS/B	Mavi	24V AC-DC	10	Q22mm Led'li Sinyal	<b>1,19 \$</b>
AD 22 - 22DS/W	Beyaz	24V AC-DC	10	Q22mm Led'li Sinyal	<b>1,19 \$</b>

## Ledli Voltmetre - Ampermetre Sinyal Lambaları

### Q22 mm Ledli Voltmetre Göstergeli Sinyal Lambaları



#### Teknik Özellikler

ÜRÜN KODU	RENK	VOLTAJ	ÇAP (mm)	K. ADEDİ	FİYAT
AD22-22DS/RV	■ KIRMIZI	12-500 VAC	22 mm	10	<b>3,50 \$</b>
AD22-22DS/GV	■ YEŞİL	12-500 VAC	22 mm	10	<b>3,50 \$</b>
AD22-22DS/YV	■ SARI	12-500 VAC	22 mm	10	<b>3,50 \$</b>

### Q22 mm Ledli Voltmetre - Ampermetre Göstergeli Sinyal Lambaları



#### Teknik Özellikler

ÜRÜN KODU	RENK	VOLTAJ	ÇAP (mm)	K. ADEDİ	FİYAT
AD22-22DS/RAV	■ KIRMIZI	12-500 VAC 0-100 A	22 mm	5	<b>9,50 \$</b>
AD22-22DS/GAV	■ YEŞİL	12-500 VAC 0-100 A	22 mm	5	<b>9,50 \$</b>
AD22-22DS/YAV	■ SARI	12-500 VAC 0-100 A	22 mm	5	<b>9,50 \$</b>

### Q22 mm Ledli Ampermetre Göstergeli Sinyal Lambaları



#### Teknik Özellikler

ÜRÜN KODU	RENK	AMP	ÇAP (mm)	K. ADEDİ	FİYAT
AD22-22DS/RA	■ KIRMIZI	0-100 A Akım Trafolu	22 mm	5	<b>7,10 \$</b>
AD22-22DS/GA	■ YEŞİL	0-100 A Akım Trafolu	22 mm	5	<b>7,10 \$</b>
AD22-22DS/YA	■ SARI	0-100 A Akım Trafolu	22 mm	5	<b>7,10 \$</b>

## XCK Plastik Gövdeli Limit Switch



XCK-SUM 211



XCK-SUM 331



XCK-SUM 332RS



XCK-SİM 311



XCK-SİM 411



XCK-SEM 121



XCK-SEM 122



XCK-SEL 123R



XCK-SOM 102

Tüm Özellikleriyle  
ÇOK ÖZEL

### XCK Plastik Gövdeli Limit Switch Özellikleri

- Estetik plastik gövde • Paslanmaz makara ve kol • Yüksek mekanik dayanıklılık • Ekstra geniş  $\pm 95^\circ$  hareketli, • PG 13.5 kablo rekoru kullanılabilir • Kompakt gövde • 1NO/1NC 2 anahtarlamalı kontak • Hareketli çift kontaklar • PG 13.5/M20x1.5 kablo rakoru girişli • IP67
- Kapak içi lastik conta • Tüm modellerde tahrik kafa contası • Gövde vidası M3+Somon sıkmalı • Kontak bloğunu çıkartarak dışarda rahat bağlantı olanağı • Gövde kapak vidası kapak üzerinden düşmez • Uluslararası gövde standartlarında.

### XCK-SUM 211

XCK Plastik Gövdeli  
Limit Switch

**FİYAT: 5,98 \$**



ÜRÜN KODU	XCK-SUM 211 (CLS101)
KONTAK TİPİ	1NO+1NC
AÇIKLAMA	Doğrusal Hareketli Metal Pim
KUTU ADEDİ	10 Adet

### XCK-SUM 331

XCK Plastik Gövdeli  
Limit Switch

**FİYAT: 5,67 \$**



ÜRÜN KODU	XCK-SUM 331 (CLS103)
KONTAK TİPİ	1NO+1NC
AÇIKLAMA	Doğrusal Hareketli 11mm Metal Makaralı Pim
KUTU ADEDİ	10 Adet

### XCK-SUM 332RS

XCK Plastik Gövdeli  
Limit Switch

**FİYAT: 5,67 \$**



ÜRÜN KODU	XCK-SUM 332RS (CLS103R)
KONTAK TİPİ	1NO+1NC
AÇIKLAMA	Doğrusal Hareketli <b>Resetli</b> 11mm Metal Makaralı Pim
KUTU ADEDİ	10 Adet

Üst kapak vidası M3 kapaktan düşmez. Kontak bloğu çıkarılabilir. Rahatlıkla kablo bağlanır.



## XCK Plastik Gövdeli Limit Switch

### XCK-SİM 311

XCK Plastik Gövdeli  
Limit Switch

**FİYAT: 5,98 \$**



<b>ÜRÜN KODU</b>	XCK-SİM 311 (CLS111)
<b>KONTAK TİPİ</b>	1NO+1NC
<b>AÇIKLAMA</b>	Açısal Hareketli 14 mm Metal Makaralı Kol
<b>KUTU ADEDİ</b>	10 Adet

### XCK-SİM 411

XCK Plastik Gövdeli  
Limit Switch

**FİYAT: 5,98 \$**



<b>ÜRÜN KODU</b>	XCK-SİM 411 (CLS127)
<b>KONTAK TİPİ</b>	1NO+1NC
<b>AÇIKLAMA</b>	Açısal Hareketli Ters Açılı 14 mm Metal Makaralı Kol
<b>KUTU ADEDİ</b>	10 Adet

### XCK-SEP 121

XCK Plastik Gövdeli  
Limit Switch

**FİYAT: 5,98 \$**



<b>ÜRÜN KODU</b>	XCK-SEP 121
<b>KONTAK TİPİ</b>	1NO+1NC
<b>AÇIKLAMA</b>	Açısal Hareketli 18 mm Plastik Makaralı Döner Kol
<b>KUTU ADEDİ</b>	10 Adet

### XCK-SEM 121

XCK Plastik Gövdeli  
Limit Switch

**FİYAT: 5,98 \$**



<b>ÜRÜN KODU</b>	XCK-SEM 121 (CLS121)
<b>KONTAK TİPİ</b>	1NO+1NC
<b>AÇIKLAMA</b>	Açısal Hareketli 18 mm Metal Makaralı Döner Kol
<b>KUTU ADEDİ</b>	10 Adet

### XCK-SEM 122

XCK Plastik Gövdeli  
Limit Switch

**FİYAT: 6,06 \$**



<b>ÜRÜN KODU</b>	XCK-SEM 122 (CLS131)
<b>KONTAK TİPİ</b>	1NO+1NC
<b>AÇIKLAMA</b>	Açısal Hareketli Ayarlanabilir 18 mm Metal Makaralı Döner Kol
<b>KUTU ADEDİ</b>	10 Adet

### XCK-SEM 123

XCK Plastik Gövdeli  
Limit Switch

**FİYAT: 6,06 \$**



<b>ÜRÜN KODU</b>	XCK-SEM 123 (CLS131M)
<b>KONTAK TİPİ</b>	1NO+1NC
<b>AÇIKLAMA</b>	Açısal Hareketli Ayarlanabilir 18 mm Metal Makaralı Döner Uzun Kol
<b>KUTU ADEDİ</b>	10 Adet

Üst kapak vidası M3 kapaktan düşmez. Kontak bloğu çıkarılabilir. Rahatlıkla kablo bağlanır.

## XCK Plastik Gövdeli Limit Switch

### XCK-SEL 123

XCK Plastik Gövdeli  
Limit Switch

**FİYAT: 5,67 \$**



ÜRÜN KODU	XCK-SEL 123 (CLS191)
KONTAK TİPİ	1NO+1NC
AÇIKLAMA	Açısal Hareketli Ayarlanabilir 50 mm Lastik Makaralı Döner Kol
KUTU ADEDİ	10 Adet

### XCK-SEL 123R

XCK Plastik Gövdeli  
Limit Switch

**FİYAT: 7,22 \$**



ÜRÜN KODU	XCK-SEL 123 R (CLS191R)
KONTAK TİPİ	1NO+1NC
AÇIKLAMA	Açısal Hareketli Ayarlanabilir 50 mm Lastik Makaralı Resetli Döner Kol
KUTU ADEDİ	10 Adet

### XCK-SOM 101

XCK Plastik Gövdeli  
Limit Switch

**FİYAT: 6,29\$**



ÜRÜN KODU	XCK-SOM 101 (CLS161)
KONTAK TİPİ	1NO+1NC
AÇIKLAMA	Açısal Hareketli Spiral Telli Çok Yönlü Kol
KUTU ADEDİ	10 Adet

### XCK-SOM 102

XCK Plastik Gövdeli  
Limit Switch

**FİYAT: 6,29 \$**



ÜRÜN KODU	XCK-SOM 102
KONTAK TİPİ	1NO+1NC
AÇIKLAMA	Açısal Hareketli Metal Uçlu Metal Spiral Çok Yönlü Kol
KUTU ADEDİ	10 Adet



Yanmaz, kırılmaz özel plastik gövde kollu ürünlerde 5° - 90° hassas ayar olanağı, uzun kol mesafesi



## CSA Metal Gövdeli Limit Switch

### CSA 001

CSA METAL GÖVDELİ LİMİT SWITCH

**FİYAT: 15,30 \$**



ÜRÜN KODU	CSA-001
KONTAK TİPİ	1NO+1NC
AÇIKLAMA	Dikey Buton Tahrikli
KUTU ADEDİ	10 Adet

### CSA 003

CSA METAL GÖVDELİ LİMİT SWITCH

**FİYAT: 15,30 \$**



ÜRÜN KODU	CSA-003
KONTAK TİPİ	1NO+1NC
AÇIKLAMA	Dikey Metal Makara Tahrikli
KUTU ADEDİ	10 Adet

### CSA 004

CSA METAL GÖVDELİ LİMİT SWITCH

**FİYAT: 15,30 \$**



ÜRÜN KODU	CSA-004
KONTAK TİPİ	1NO+1NC
AÇIKLAMA	Dikey Ters Metal Makara Tahrikli
KUTU ADEDİ	10 Adet

### CSA 012

CSA METAL GÖVDELİ LİMİT SWITCH

**FİYAT: 15,30 \$**



ÜRÜN KODU	CSA-012
KONTAK TİPİ	1NO+1NC
AÇIKLAMA	Yatay Metal Makara Kol Tahrikli
KUTU ADEDİ	10 Adet

### CSA 031

CSA METAL GÖVDELİ LİMİT SWITCH

**FİYAT: 15,30 \$**



ÜRÜN KODU	CSA-031
KONTAK TİPİ	1NO+1NC
AÇIKLAMA	Ø 18mm Ayarlanabilir Sağ-Sol Metal Makara Tahrikli
KUTU ADEDİ	10 Adet

### CSA 061

CSA METAL GÖVDELİ LİMİT SWITCH

**FİYAT: 15,30 \$**



ÜRÜN KODU	CSA-061
KONTAK TİPİ	1NO+1NC
AÇIKLAMA	Spiral Metal Tel Tahrikli
KUTU ADEDİ	10 Adet

### CSA 071

CSA METAL GÖVDELİ LİMİT SWITCH

**FİYAT: 15,30 \$**



ÜRÜN KODU	CSA-071
KONTAK TİPİ	1NO+1NC
AÇIKLAMA	Spiral Plastik Yay Tahrikli
KUTU ADEDİ	10 Adet

Üst kapak vidası M3 kapaktan düşmez. Kontak bloğu çıkarılabilir. Rahatlıkla kablo bağlanır.

## Mini Switch (Silver Contact)

### XZ-15GQ-B

Mini Switch  
(Silver Contact) / 15 Amper

**FİYAT: 3,35 \$**



ÜRÜN KODU	XZ-15GQ-B (CM1307)
KONTAK TİPİ	1NO+1NC
AÇIKLAMA	Kalın Uzun Pimli
AMPER	15 A
KUTU ADEDİ	20 Adet

### XZ-15GQ22-B

Mini Switch  
(Silver Contact) / 15 Amper

**FİYAT: 3,60 \$**



ÜRÜN KODU	XZ-15GQ22-B
KONTAK TİPİ	(CM1308)
AÇIKLAMA	1NO+1NC Yatay Metal Makara Pim
AMPER	15 A
KUTU ADEDİ	20 Adet

### XZ-15GQ21-B

Mini Switch  
(Silver Contact) / 15 Amper

**FİYAT: 3,60 \$**



ÜRÜN KODU	XZ-15GQ21-B (CM1309)-
KONTAK TİPİ	1NO+1NC
AÇIKLAMA	Dikey Metal Makara Pim
AMPER	15 A
KUTU ADEDİ	20 Adet

### XZ-15GW-B

Mini Switch  
(Silver Contact) / 15 Amper

**FİYAT: 3,33 \$**



ÜRÜN KODU	XZ-15GW-B (CM1701)
KONTAK TİPİ	1NO+1NC
AÇIKLAMA	Uzun Palet
AMPER	15 A
KUTU ADEDİ	20 Adet

### XZ-15GW22-B

Mini Switch  
(Silver Contact) / 15 Amper

**FİYAT: 3,05 \$**



ÜRÜN KODU	XZ-15GW22-B (CM1704)
KONTAK TİPİ	1NO+1NC
AÇIKLAMA	Kısa Palet Metal Makaralı
AMPER	15 A
KUTU ADEDİ	20 Adet

### XZ-15GW3-B

Mini Switch  
(Silver Contact) / 15 Amper

**FİYAT: 4,73 \$**

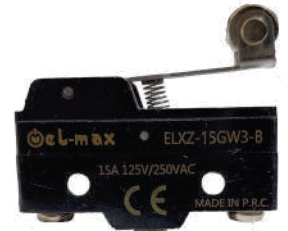

ÜRÜN KODU	XZ-15GW3-B
KONTAK TİPİ	1NO+1NC
AÇIKLAMA	Orta Palet Metal Makaralı
AMPER	15 A
KUTU ADEDİ	20 Adet

## Mini Switch (Silver Contact)

**XZ-15GW2-B**  
Mini Switch  
(Silver Contact) / 15 Amper

**FİYAT: 3,33 \$**

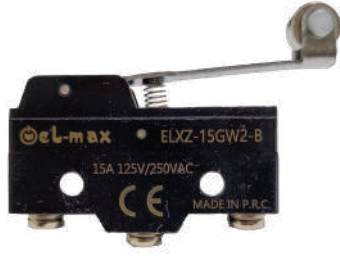

<b>ÜRÜN KODU</b>	XZ-15GW2-B (CM1703)
<b>KONTAK TİPİ</b>	1NO+1NC
<b>AÇIKLAMA</b>	Uzun Palet Metal Makaralı
<b>AMPER</b>	15 A
<b>KUTU ADEDİ</b>	20 Adet

**XAP-Y**  
Mini Switch Kapağı

**FİYAT: 0,95 \$**



<b>ÜRÜN KODU</b>	XAP-Y
<b>AÇIKLAMA</b>	Mini Siviç Koruma Kılıfı 45° Açılı Kauçuk
<b>AMPER</b>	15 A
<b>KUTU ADEDİ</b>	100 Adet





## Mikro Switch (Silver Contact)

### XV-15-1C25

Mikro Switch  
(Silver Contact) / 15 Amper

**FİYAT: 1,19 \$**



ÜRÜN KODU	XV-15-1C25
KONTAK TİPİ	1NO+1NC
AÇIKLAMA	Buton Tip Pimli
KUTU ADEDİ	100 Adet

### XV-151-1C25

Mikro Switch  
(Silver Contact) / 15 Amper

**FİYAT: 1,19 \$**



ÜRÜN KODU	XV-151-1C25
KONTAK TİPİ	1NO+1NC
AÇIKLAMA	Kısa Palet
KUTU ADEDİ	100 Adet

### XV-152-1C25

Mikro Switch  
(Silver Contact) / 15 Amper

**FİYAT: 1,19 \$**



ÜRÜN KODU	XV-152-1C25 Orta Palet
KONTAK TİPİ	1NO+1NC
AÇIKLAMA	Orta Palet
KUTU ADEDİ	100 Adet

### XV-153-1C25

Mikro Switch  
(Silver Contact) /  
15 Amper

**FİYAT: 1,19 \$**



ÜRÜN KODU	XV-153-1C25
KONTAK TİPİ	1NO+1NC
AÇIKLAMA	Uzun Palet
KUTU ADEDİ	100 Adet

### XV-154-1C25

Mikro Switch  
(Silver Contact) /  
15 Amper

**FİYAT: 1,19 \$**



ÜRÜN KODU	XV-154-1C25
KONTAK TİPİ	1NO+1NC
AÇIKLAMA	Çengel Palet
KUTU ADEDİ	100 Adet

### XV-155-1C25

Mikro Switch  
(Silver Contact) /  
15 Amper

**FİYAT: 1,19 \$**



ÜRÜN KODU	XV-155-1C25
KONTAK TİPİ	1NO+1NC
AÇIKLAMA	Kısa Palet Pls. Makaralı
KUTU ADEDİ	100 Adet

### XV-156-1C25

Mikro Switch  
(Silver Contact) /  
15 Amper

**FİYAT: 1,19 \$**



ÜRÜN KODU	XV-156-1C25
KONTAK TİPİ	1NO+1NC
AÇIKLAMA	Uzun Palet Makaralı
KUTU ADEDİ	100 Adet

## İzoleli Kablo Yüksükleri (Bakır Copper)

Standart : DIN 46228  
Malzeme : Bakır Kalay Kaplı  
İzolasyon : Naylon  
Çalışma Sıcaklığı : Max 105°  
600 Volt Arası



Standart : DIN 46228  
Malzeme : Bakır Kalay Kaplı  
İzolasyon : Naylon



### İzoleli Kablo Yüksükleri Wire End Sleeves Insul / KUTULU

ÜRÜN KODU	KESİT (mm)	FRANCE NORM	BOYUTLAR		PLS KUTU / ADET	FİYAT
			F mm	L mm		
ELX IY 3005	0,50	Beyaz	8	12	1,000	0,145 ₺
ELX IY 3007	0,75	Mavi	8	14	1,000	0,145 ₺
ELX IY 3010	1	Kırmızı	8	14	1,000	0,145 ₺
ELX IY 3015	1,5	Siyah	8	14	1,000	0,158 ₺
ELX IY 3025	2,5	Gri	8	14	500	0,202 ₺
ELX IY 3040	4	Turuncu	10	17	500	0,333 ₺
ELX IY 3060	6	Yeşil	12	20	250	0,452 ₺
ELX IY 3100	10	Kahverengi	12	22	100	0,572 ₺
ELX IY 3160	16	Bej	12	24	100	0,813 ₺
ELX IY 3250	25	Siyah	16	28	50	1,40 ₺
ELX IY 3350	35	Kırmızı	16	30	50	1,68 ₺
ELX IY 3500	50	Mavi	20	36	25	3,20 ₺

### İzoleli Kablo Yüksükleri Wire End Sleeves Insul / KUTULU

ÜRÜN KODU	KESİT (mm)	GERMANY NORM	BOYUTLAR		PLS KUTU / ADET	FİYAT
			F mm	L mm		
ELX IY 2005	0,50	Turuncu	8	12	1,000	0,145 ₺
ELX IY 2007	0,75	Beyaz	8	14	1,000	0,145 ₺
ELX IY 2010	1	Sarı	8	14	1,000	0,145 ₺
ELX IY 2015	1,5	Kırmızı	8	14	1,000	0,158 ₺
ELX IY 2025	2,5	Mavi	8	14	500	0,202 ₺
ELX IY 2040	4	Gri	10	17	500	0,333 ₺
ELX IY 2060	6	Siyah	12	20	250	0,452 ₺
ELX IY 2100	10	Bej	12	22	100	0,572 ₺
ELX IY 2160	16	Yeşil	12	24	100	0,813 ₺
ELX IY 2250	25	Kahverengi	16	28	50	1,40 ₺
ELX IY 2350	35	Bej	16	30	50	1,68 ₺
ELX IY 2500	50	Siyah	20	36	25	3,20 ₺

### İzoleli Çift Girişli Kablo Yüksükleri Twin Wire End Sleeves Insul / KUTULU

ÜRÜN KODU	KESİT mm	FRANCE NORM	GERMANY NORM	BOYUTLAR		PLS KUTU	FİYAT
		Fransız	Alman	F mm	L mm	Adet	
ELX CY 23005	0,50	Beyaz	Kahverengi	8	14	500	0,256 ₺
ELX CY 23007	0,75	Mavi	Beyaz	8	14	500	0,269 ₺
ELX CY 23010	1	Kırmızı	Sarı	8	14	500	0,286 ₺
ELX CY 23015	1,5	Siyah	Kırmızı	8	14	500	0,346 ₺
ELX CY 23025	2,5	Gri	Mavi	10	14	250	0,565 ₺
ELX CY 23040	4	Turuncu	Gri	12	17	200	0,650 ₺
ELX CY 23060	6	Yeşil	Siyah	14	20	100	0,805 ₺
ELX CY 23100	10	Kahverengi	Beyaz	14	27	100	1,284 ₺
ELX CY 23160	16	Bej	Yeşil	14	31	50	1,550 ₺

## İzoleli Papuçlar

### İzoleli 0,50-1,50 Kablo Girişli Yuvarlak Papuçlar

Standart : DIN 46237  
Malzeme : Bakır Kalay Kaplı  
İzolasyon : PVC  
Çalışma Sıcaklığı : Max 105°  
600 Volt Arası



#### Teknik Özellikler

ÜRÜN KODU	RENK	KESİT	K. ADEDİ	AÇIKLAMA	FİYAT
ELX YU 301	■ Kırmızı	0,50 - 1,5	200	M 3 İzoleli Papuçlar	<b>0,659 ₺</b>
ELX YU 401	■ Kırmızı	0,50 - 1,5	200	M 4 İzoleli Papuçlar	<b>0,685 ₺</b>
ELX YU 501	■ Kırmızı	0,50 - 1,5	200	M 5 İzoleli Papuçlar	<b>0,692 ₺</b>
ELX YU 601	■ Kırmızı	0,50 - 1,5	200	M 6 İzoleli Papuçlar	<b>1,087 ₺</b>
ELX YU 801	■ Kırmızı	0,50 - 1,5	200	M 8 İzoleli Papuçlar	<b>1,12 ₺</b>

### İzoleli 0,50-250 Kablo Girişli Yuvarlak Papuçlar



#### Teknik Özellikler

ÜRÜN KODU	RENK	KESİT	K. ADEDİ	AÇIKLAMA	FİYAT
ELX YU 302	■ Mavi	1,50 - 2,5	200	M 3 İzoleli Papuçlar	<b>0,840 ₺</b>
ELX YU 402	■ Mavi	1,50 - 2,5	200	M 4 İzoleli Papuçlar	<b>0,840 ₺</b>
ELX YU 502	■ Mavi	1,50 - 2,5	200	M 5 İzoleli Papuçlar	<b>0,855 ₺</b>
ELX YU 602	■ Mavi	1,50 - 2,5	200	M 6 İzoleli Papuçlar	<b>1,216 ₺</b>
ELX YU 802	■ Mavi	1,50 - 2,5	200	M 8 İzoleli Papuçlar	<b>1,218 ₺</b>
ELX YU 1002	■ Mavi	1,50 - 2,5	200	M 10 İzoleli Papuçlar	<b>1,220 ₺</b>
ELX YU 1202	■ Mavi	1,50 - 2,5	200	M 12 İzoleli Papuçlar	<b>1,50 ₺</b>

### İzoleli 4,0 - 6,0 Kablo Girişli Yuvarlak Papuçlar



#### Teknik Özellikler

ÜRÜN KODU	RENK	KESİT	K. ADEDİ	AÇIKLAMA	FİYAT
ELX YU 406	■ Sarı	4,0 - 6,0	100	M 4 İzoleli Papuçlar	<b>1,77 ₺</b>
ELX YU 506	■ Sarı	4,0 - 6,0	100	M 5 İzoleli Papuçlar	<b>1,77 ₺</b>
ELX YU 606	■ Sarı	4,0 - 6,0	100	M 6 İzoleli Papuçlar	<b>1,99 ₺</b>
ELX YU 806	■ Sarı	4,0 - 6,0	100	M 8 İzoleli Papuçlar	<b>2,53 ₺</b>
ELX YU 1006	■ Sarı	4,0 - 6,0	100	M 10 İzoleli Papuçlar	<b>2,56 ₺</b>
ELX YU 1206	■ Sarı	4,0 - 6,0	100	M 12 İzoleli Papuçlar	<b>2,61 ₺</b>

### İzoleli 0,50 - 1,5 Kablo Girişli Çatal Papuçlar

Standart : DIN 46237  
Malzeme : Bakır Kalay Kaplı  
İzolasyon : PVC  
Çalışma Sıcaklığı : Max 105°  
600 Volt Arası



#### Teknik Özellikler

ÜRÜN KODU	RENK	KESİT	K. ADEDİ	AÇIKLAMA	FİYAT
ELX ÇU 3001	■ Kırmızı	0,50 - 1,5	200	M 3 İzoleli Papuçlar	<b>0,600 ₺</b>
ELX ÇU 4001	■ Kırmızı	0,50 - 1,5	200	M 4 İzoleli Papuçlar	<b>0,611 ₺</b>
ELX ÇU 5001	■ Kırmızı	0,50 - 1,5	200	M 5 İzoleli Papuçlar	<b>0,65 ₺</b>
ELX ÇU 6001	■ Kırmızı	0,50 - 1,5	200	M 6 İzoleli Papuçlar	<b>0,736 ₺</b>

## İzoleli Pabuçlar

### İzoleli 1,50 - 2,5 Kablo Girişli Çatal Papuçlar



#### Teknik Özellikler

ÜRÜN KODU	RENK	KESİT	K. ADEDİ	AÇIKLAMA	FİYAT
ELX ÇU 3002	Mavi	1,5 - 2,5	200	M 3 İzoleli Papuçlar	<b>0,675 ₺</b>
ELX ÇU 4002	Mavi	1,5 - 2,5	200	M 4 İzoleli Papuçlar	<b>0,693 ₺</b>
ELX ÇU 5002	Mavi	1,5 - 2,5	200	M 5 İzoleli Papuçlar	<b>0,705 ₺</b>
ELX ÇU 6002	Mavi	1,5 - 2,5	200	M 6 İzoleli Papuçlar	<b>0,948 ₺</b>

### İzoleli 4,0 - 6,0 Kablo Girişli Çatal Papuçlar



#### Teknik Özellikler

ÜRÜN KODU	RENK	KESİT	K. ADEDİ	AÇIKLAMA	FİYAT
ELX ÇU 4006	Sarı	4,0 - 6,0	100	M 4 İzoleli Papuçlar	<b>1,56 ₺</b>
ELX ÇU 5006	Sarı	4,0 - 6,0	100	M 5 İzoleli Papuçlar	<b>1,60 ₺</b>
ELX ÇU 6006	Sarı	4,0 - 6,0	100	M 6 İzoleli Papuçlar	<b>2,12 ₺</b>
ELX ÇU 8006	Sarı	4,0 - 6,0	100	M 8 İzoleli Papuçlar	<b>2,43 ₺</b>

### İğne Tip İzoleli Kablo Uçları



#### Teknik Özellikler

Malzeme : Bakır Kalay Kaplı  
İzolasyon : PVC  
Çalışma Sıcaklığı : Max 75° / 300 Volt Arası

ÜRÜN KODU	RENK	KESİT	K. ADEDİ	AÇIKLAMA	FİYAT
ELX K 101	Kırmızı	0,5 - 1,5	200	1,9 x 10,5 Kablo Uçları	<b>0,711 ₺</b>
ELX K 102	Mavi	1,5 - 2,5	200	1,9 x 20,5 Kablo Uçları	<b>0,837 ₺</b>
ELX K 106	Sarı	4,0 - 6,0	200	2,8 x 26 Kablo Uçları	<b>2,10 ₺</b>

### Kurşun Tip Dişi Terminal



#### Teknik Özellikler

Malzeme : Pirinç, Kalay Kaplı  
Bakır Yüksüklü  
İzolasyon : PVC  
Çalışma Sıcaklığı : Max 75° / 300 Volt Arası

ÜRÜN KODU	RENK	KESİT	K. ADEDİ	AÇIKLAMA	FİYAT
ELX BD 1040	Kırmızı	0,5 - 1,5	200	Q4 L9 Dişi Terminal	<b>1,90 ₺</b>
ELX BD 2050	Mavi	1,5 - 2,5	200	Q5 L9 Dişi Terminal	<b>2,12 ₺</b>

## Terminal



### Kurşun Tip Erkek Terminal



#### Teknik Özellikler

Malzeme : Pirinç, Kalay Kaplı  
Bakır Yüksüklü  
İzolasyon : PVC  
Çalışma Sıcaklığı : Max 75° / 300 Volt Arası

ÜRÜN KODU	RENK	KESİT	K. ADEDİ	AÇIKLAMA	FİYAT
ELX BE 2050	Mavi	1,5 - 2,5	200	Q5 L8,5 Erkek Terminal	<b>1,81 ₺</b>

### Polyamid Tam İzole Bayrak Tip Terminal



#### Teknik Özellikler

Malzeme : Pirinç, Kalay Kaplı  
İzolasyon : Polyamid  
Çalışma Sıcaklığı : Max 105° / 300 Volt Arası

ÜRÜN KODU	RENK	KESİT	K. ADEDİ	AÇIKLAMA	FİYAT
ELX FDEG 1861	Kırmızı	0,50 - 1,5	100	6,3 mm Terrminal	<b>1,93 ₺</b>

### Tam İzole PVC Dişi Terminal



#### Teknik Özellikler

Malzeme : Pirinç, Kalay Kaplı  
İzolasyon : PVC  
Çalışma Sıcaklığı : Max 75° / 300 Volt Arası

ÜRÜN KODU	RENK	KESİT	K. ADEDİ	AÇIKLAMA	FİYAT
ELX FFD 1488	Kırmızı	0,5 - 1,5	200	4,8 mm	<b>1,022 ₺</b>
ELX FFD 1638	Kırmızı	0,5 - 1,5	100	6,3 mm	<b>1,18 ₺</b>
ELX FFD 2488	Mavi	1,5 - 2,5	200	4,8 mm	<b>1,13 ₺</b>
ELX FFD 2638	Mavi	1,5 - 2,5	100	6,3 mm	<b>1,18 ₺</b>
ELX FFD 5638	Sarı	4,0 - 6,0	200	6,3 mm	<b>1,48 ₺</b>

## Terminal

### İzoleli Dişi Terminal



#### Teknik Özellikler

Malzeme : Pirinç, Kalay Kaplı  
İzolasyon : PVC  
Çalışma Sıcaklığı : Max 75° / 300 Volt Arası

ÜRÜN KODU	RENK	KESİT	K. ADEDİ	AÇIKLAMA	FİYAT
ELX FD 1488	■ Kırmızı	0,5-1,5	200	4,8 mm Dişi Terminal	<b>0,76 ₺</b>
ELX FD 1638	■ Kırmızı	0,5-1,5	200	6,3 mm Dişi Terminal	<b>0,88 ₺</b>
ELX FD 2638	■ Mavi	1,5-2,5	200	6,3 mm Dişi Terminal	<b>1,1 ₺</b>
ELX FD 5638	■ Sarı	4,0-6,0	150	6,3 mm Dişi Terminal	<b>1,20 ₺</b>



## Terminal

### İzoleli Erkek Terminal



#### Teknik Özellikler

Malzeme : Pirinç, Kalay Kaplı  
İzolasyon : PVC  
Çalışma Sıcaklığı : Max 75° /300 Volt Arası

ÜRÜN KODU	RENK	KESİT	K. ADEDİ	AÇIKLAMA	FİYAT
ELX FE 1288	Kırmızı	0,5 - 1,5	200	2,8 mm Terminal	<b>0,606 ₺</b>
ELX FE 1488	Kırmızı	0,5 - 1,5	200	4,8 mm Terminal	<b>0,606 ₺</b>
ELX FE 1638	Kırmızı	0,5 - 1,5	200	6,3 mm Terminal	<b>0,723 ₺</b>
ELX FE 2488	Mavi	1,5 - 2,5	200	4,8 mm Terminal	<b>0,606 ₺</b>
ELX FE 2638	Mavi	1,5 - 2,5	200	6,3 mm Terminal	<b>0,790 ₺</b>
ELX FE 5638	Sarı	4,0 - 6,0	150	6,3 mm Terminal	<b>0,945 ₺</b>

### İzolesiz Dişi Terminal



#### Teknik Özellikler

ÜRÜN KODU	K. ADEDİ	AÇIKLAMA	FİYAT
ELX SF 1D	300	6,3 Dişi Terminal	<b>0,660 ₺</b>
ELX SF 2D	300	6,3 Dişi Tırnaklı Terminal	<b>0,660 ₺</b>
ELX SF 1/2D	1000	2,8 Dişi Terminal	<b>0,425 ₺</b>
ELX SF 1D Mini	500	4,8 Dişi Terminal	<b>0,515 ₺</b>
ELX SF 1D Kılıf	300	6,3 Terminal Kılıfı	<b>0,315 ₺</b>

### İzolesiz Erkek Terminal



#### Teknik Özellikler

ÜRÜN KODU	K. ADEDİ	AÇIKLAMA	FİYAT
ELX SF 1EÇK	300	6,3 Kısa Erkek Terminal	<b>0,685 ₺</b>
ELX SF 1EU1	400	6,3 Uzun Erkek Terminal	<b>0,860 ₺</b>

### İzolesiz Erkek Terminal



#### Teknik Özellikler

ÜRÜN KODU	K. ADEDİ	AÇIKLAMA	FİYAT
ELX SKN 2,5	500	M4 M5 M6 Topraklama Terminal	<b>0,66 ₺</b>
ELX SKN 4	250	M4 M5 M6 Topraklama Terminal	<b>1,24 ₺</b>
ELX SKN 6	150	M6 Topraklama Terminal	<b>1,9 ₺</b>
ELX SKN 8	150	M8 Topraklama Terminal	<b>1,9 ₺</b>
ELX SKN 10	100	M8 M10 Topraklama Terminal	<b>2,17 ₺</b>

## Ekonomik Kablo Pabuçları

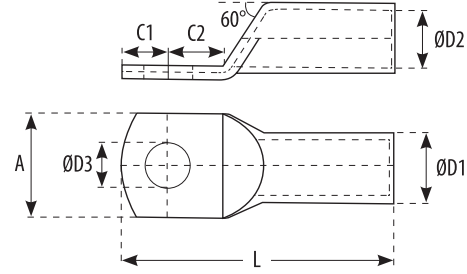
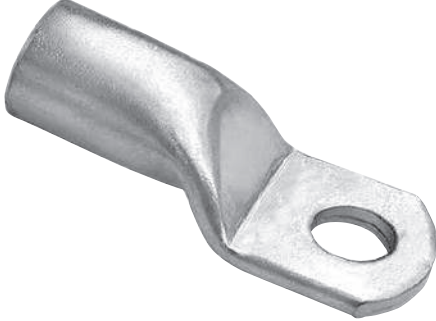

Elektrolit Bakır 99.9  
İletkenlik Katsayı min. 56 ms/m

Ürün Kodu	Kablo Kesiti mm2	Civata	Ölçüler					Kutu Adet	Adet Fiyat (USD)
			D3	D2	D1	L	A		
SKPE-16-06	16	M6	6,5	5,8	7,4	30	12	500	0,255 \$
SKPE-16-08	16	M6	6,5	5,8	7,4	30	12	500	0,255 \$
SKPE-25-08	25	M8	8,5	7,2	9,2	40	14	350	0,452 \$
SKPE-35-08	35	M8	8,5	8,5	11	44	15,3	200	0,626 \$
SKPE-50-10	50	M10	10,5	10	13	52	20	150	0,783 \$
SKPE-70-10	70	M10	10,5	11,5	14,7	55	22	100	1,22 \$
SKPE-95-12	95	M12	13	13,5	16,7	59	26	80	1,45 \$
SKPE-120-12	120	M12	13	15,6	19	70	29	50	2,17 \$
SKPE-150-12	150	M12	13	17	21	77	32	40	3,05 \$
SKPE-185-16	185	M16	17	19	23	85	35	30	3,88 \$
SKPE-240-16	240	M16	17	21	26	90	38,5	25	5,70 \$

## Ek Muflar



Ürün Kodu	Uzunluk mm2	Kutu Adet	Adet Fiyat (USD)
EM-16	32	400	0,37 \$
EM-25	41	250	0,52 \$
EM-35	46	200	0,75 \$
EM-50	54	150	0,835 \$
EM-70	58	100	1,39 \$
EM-95	62	75	1,60 \$
EM-120	74	60	2,30 \$
EM-150	80	40	3,48 \$
EM-185	86	25	4,17 \$
EM-240	95	25	6,11 \$



## Kablo Pabuçları

Ürün Kodu	Kablo Kesiti mm2	Civata	Ölçüler					Kutu Adet	Adet Fiyat (USD)
			D3	D2	D1	L	A		
SKPS-10-06	10	M6	6,5	4,7	6,5	27,5	10,5	800	0,398 \$
SKPS-10-08		M8	8,5	4,7	6,5	27,5	13,0	800	0,398 \$
SKPS-16-06	16	M6	6,5	5,8	7,4	30	12	500	0,50 \$
SKPS-16-08		M8	8,5	5,8	7,8	30	12	500	0,50 \$
SKPS-25-06	25	M6	6,5	7,0	9,2	40	14	350	0,796 \$
SKPS-25-08		M8	8,5	7,0	9,2	40	14	350	0,796 \$
SKPS-25-10		M10	10,5	7,0	9,5	40	14	350	0,824 \$
SKPS-35-06	35	M6	6,5	8,2	10,7	44	15,3	200	1,064 \$
SKPS-35-08		M8	8,5	8,2	10,7	44	15,3	200	1,064 \$
SKPS-35-10		M10	10,5	8,2	10,7	44	15,3	200	1,064 \$
SKPS-50-08	50	M6	8,5	10,2	12,8	52	20	150	1,638 \$
SKPS-50-10		M10	10,5	10,2	12,8	52	20	150	1,638 \$
SKPS-50-12		M12	13	10,2	12,8	52	20	150	1,712 \$
SKPS-70-08	70	M8	8,5	11,7	14,7	55	22	100	2,22 \$
SKPS-70-10		M10	10,5	11,7	14,7	55	22	100	2,50 \$
SKPS-70-12		M12	13	11,7	14,7	55	22	100	2,22 \$
SKPS-95-08	95	M8	8,5	13,6	16,7	59	26	80	2,50 \$
SKPS-95-10		M10	10,5	13,6	16,7	59	26	80	2,36 \$
SKPS-95-12		M12	13	13,6	16,7	59	26	80	2,36 \$
SKPS-120-10	120	M10	10,5	15,5	19	70	29	50	3,37 \$
SKPS-120-12		M12	13	15,5	19	70	29	50	3,24 \$
SKPS-150-10	150	M10	10,5	16,7	21	77	32	40	5,18 \$
SKPS-150-12		M12	13	16,7	21	77	32	40	5,09 \$
SKPS-185-10	185	M10	10,5	18,8	23	85	35	30	6,20 \$
SKPS-185-12		M12	13	18,8	23	85	35	30	5,92 \$
SKPS-185-16		M16	17	18,8	23	85	35	30	5,92 \$
SKPS-240-10	240	M10	10,5	21,2	26	90	38,5	25	8,33 \$
SKPS-240-12		M12	13	21,2	26	90	38,5	25	7,96 \$
SKPS-240-16		M16	17	21,2	26	90	38,5	25	7,96 \$

## Bimetal(Al-Cu) SKP Kablo Pabucu

ÜRÜN KODU	KABLO KESİTİ (mm <sup>2</sup> )	D (mm)	d±1 (mm)	L±2 (mm)	L1 (mm)	S±0,5 (mm)	Ø±0,5 (mm)	ADET \$	KUTU ADEDİ	Delik Çapı Ø	KOLİ ADEDİ
DTL-2-16	16	16	5,5	80	38	3,5	11	3,00 \$	80	M10	480
DTL-2-25	25	16	6,5	80	38	3,5	11	3,00 \$	80	M10	480
DTL-2-35	35	16	8,2	80	38	3,5	11	3,00 \$	80	M10	480
DTL-2-50	50	20	9,7	90	43	4,5	13	3,70 \$	60	M12	360
DTL-2-70	70	20	11	90	43	4,5	13	3,70 \$	60	M12	360
DTL-2-95	95	20	12,5	90	43	4,5	13	3,70 \$	60	M12	360
DTL-2-120	120	25	14,5	114	58	5,5	13	6,55 \$	30	M12	180
DTL-2-150	150	25	16,5	114	58	5,5	13	6,55 \$	30	M12	180
DTL-2-185	185	32	17,5	124	60	6	13	11,00 \$	15	M12	90
DTL-2-240	240	32	19,5	124	60	6	13	11,00 \$	15	M12	90
DTL-2-300	300	34	23	130	60	6,5	13	12,90 \$	15	M16	90
DTL-2-400	400	40	26	155	90	7	13	20,70 \$	5	M16	50



### Teknik Özellikler İletken Malzeme

Malzeme : %99.9 Aliminyum ve Bakır

Çekme Derecesi : 110Mpa

Çalışma Sıcaklığı : -40°C --- +100°C

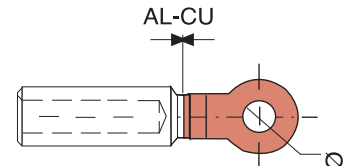
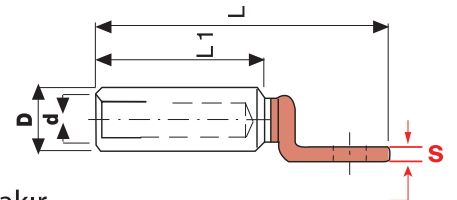

## Bakır Alüminyumlu SKP (Bimetalik Uzun Tip)



ÜRÜN KODU	KABLO KESİTİ (mm <sup>2</sup> )	D (mm)	d (mm)	L±1 (mm)	L1 (mm)	L2 (mm)	W (mm)	S (mm)	Ø (mm)	KUTU ADEDİ	FİYAT/ADET (USD)
<b>CAL-16C</b>	<b>16</b>	16	5,5	82	38	50	14	3,2	8,5	80	4,60 \$
<b>CAL-25C</b>	<b>25</b>	16	6,5	82	38	50	14	3,2	8,5	80	4,60 \$
<b>CAL-35C</b>	<b>35</b>	16	8,2	82	38	50	14	3,2	8,5	80	4,60 \$
<b>CAL-50C</b>	<b>50</b>	20	9,7	94	43	55	16	5	8,5	60	6,20 \$
<b>CAL-70C</b>	<b>70</b>	20	11	94	43	55	16	5	8,5	60	6,20 \$
<b>CAL-95C</b>	<b>95</b>	20	12,5	94	43	55	16	5	8,5	60	6,20 \$

## Bimetalik Ek Muf (Pinli)



ÜRÜN KODU	KABLO KESİTİ (mm <sup>2</sup> )	D (mm)	D1 (mm)	d (mm)	L (mm)	L1 (mm)	KUTU ADEDİ	FİYAT/ADET \$
<b>CTL-10</b>	<b>10</b>	<b>6</b>	12	5	58	30	220	3,10 \$
<b>CTL-16</b>	<b>16</b>	<b>6</b>	12	5,5	58	30	220	3,10 \$
<b>CTL-25</b>	<b>25</b>	<b>6</b>	12	7	58	30	200	3,10 \$
<b>CTL-35</b>	<b>35</b>	<b>7</b>	14	8,2	70	40	140	3,38 \$
<b>CTL-50</b>	<b>50</b>	<b>8</b>	16	10	74	40	100	3,80 \$
<b>CTL-70</b>	<b>70</b>	<b>10</b>	18	11,5	88	45	60	4,45 \$
<b>CTL-95</b>	<b>95</b>	<b>12</b>	23	13	94	45	40	6,00 \$
<b>CTL-120</b>	<b>120</b>	<b>12</b>	23	14,8	97	45	40	8,00 \$

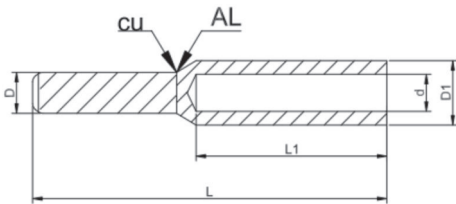

### CTL

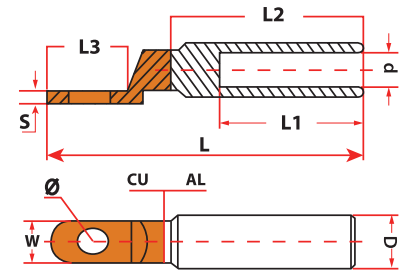

### CAL

## Dağıtım Ünitesi

### 1 Kutuplu Dağıtım Ünitesi Ray Geçmeli Kapaklı ( 7x12 mm 125 Amp)

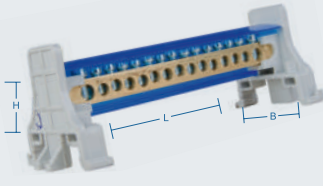

#### Teknik Özellikler

ÜRÜN KODU	AÇIKLAMA	L	B	H	KOLİ ADEDİ	FİYAT
2007	2 + 5 7 DELİKLİ ÜNİTE	76	44	42	70	<b>67,80 ₺</b>
2010	2 + 8 10 DELİKLİ ÜNİTE	100	44	42	60	<b>79,00 ₺</b>
2012	2 + 10 12 DELİKLİ ÜNİTE	115	44	42	55	<b>93,60 ₺</b>
2015	2 + 13 15 DELİKLİ ÜNİTE	135	44	42	45	<b>105,0 ₺</b>
2020	2 + 18 20 DELİKLİ ÜNİTE	170	44	42	35	<b>147,0 ₺</b>
2022	2 + 20 22 DELİKLİ ÜNİTE	185	44	42	30	<b>162,0 ₺</b>
2025	2 + 23 25 DELİKLİ ÜNİTE	207	44	42	25	<b>184,0 ₺</b>
2030	2 + 28 30 DELİKLİ ÜNİTE	245	44	42	25	<b>210,0 ₺</b>

### 2 Kutuplu Dağıtım Ünitesi ( 7x12 mm 125 Amp)

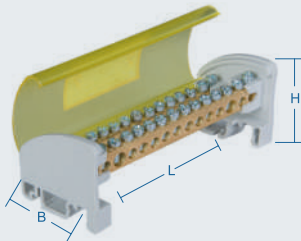

#### Teknik Özellikler

ÜRÜN KODU	AÇIKLAMA	L	B	H	KOLİ ADEDİ	FİYAT
1407	2 + 5 7 DELİKLİ DAĞITIM ÜNİTESİ	65	45	47	22	<b>139,8 ₺</b>
1410	2 + 8 10 DELİKLİ DAĞITIM ÜNİTESİ	88	45	47	15	<b>155,8 ₺</b>
1412	2 + 10 12 DELİKLİ DAĞITIM ÜNİTESİ	102	45	47	14	<b>174,0 ₺</b>
1415	2 + 13 15 DELİKLİ DAĞITIM ÜNİTESİ	126	45	47	12	<b>224,0 ₺</b>
1420	2 + 18 20 DELİKLİ DAĞITIM ÜNİTESİ	162	45	47	6	<b>286,0 ₺</b>
1422	2 + 20 22 DELİKLİ DAĞITIM ÜNİTESİ	175	45	47	6	<b>309,0 ₺</b>

### 4 Kutuplu Dağıtım Ünitesi ( 7x12 mm 125 Amp)

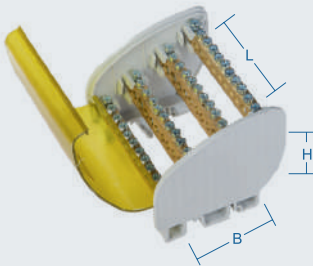

#### Teknik Özellikler

ÜRÜN KODU	AÇIKLAMA	L	B	H	KOLİ ADEDİ	FİYAT
1507	2 + 5 7 DELİKLİ DAĞITIM ÜNİTESİ	60	80	75	10	<b>277,0 ₺</b>
1510	2 + 8 10 DELİKLİ DAĞITIM ÜNİTESİ	83	80	75	8	<b>298,0 ₺</b>
1512	2 + 10 12 DELİKLİ DAĞITIM ÜNİTESİ	97	80	75	6	<b>334,00 ₺</b>
1515	2 + 13 15 DELİKLİ DAĞITIM ÜNİTESİ	120	80	75	5	<b>412,5 ₺</b>
1520	2 + 18 20 DELİKLİ DAĞITIM ÜNİTESİ	155	80	75	4	<b>538,5 ₺</b>
1522	2 + 20 22 DELİKLİ DAĞITIM ÜNİTESİ	170	80	75	4	<b>573,0 ₺</b>
1525	2 + 23 25 DELİKLİ DAĞITIM ÜNİTESİ	191	80	75	4	<b>664,5 ₺</b>

## Dağıtım Ünitesi

### 4 Kutuplu 10x15 Kesit 160 AMP Dağıtıcı Üniteler (Ayak Geçmeli) Alçak Model

#### Teknik Özellikler

ÜRÜN KODU	AÇIKLAMA	L	B	H	KOLİ ADEDİ	FİYAT
3207	2 + 5 7 DELİKLİ ÜNİTE	105	144	55	12	<b>509,9 ₺</b>
3210	2 + 8 10 DELİKLİ ÜNİTE	145	144	55	8	<b>744,8 ₺</b>
3212	2 + 10 12 DELİKLİ ÜNİTE	165	144	55	8	<b>882,0 ₺</b>
3215	2 + 13 15 DELİKLİ ÜNİTE	200	144	55	6	<b>1100,0 ₺</b>
3220	2 + 18 20 DELİKLİ ÜNİTE	255	144	55	4	<b>1432,0 ₺</b>
3222	2 + 20 22 DELİKLİ ÜNİTE	275	144	55	4	<b>1489,0 ₺</b>

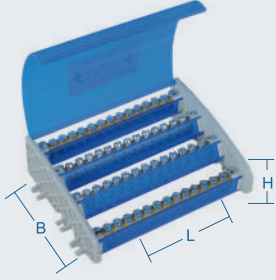

### 5 Kutuplu 10x15 Kesit 160 AMP Dağıtıcı Üniteler Yüksek Model

#### Teknik Özellikler

ÜRÜN KODU	AÇIKLAMA	L	B	H	KOLİ ADEDİ	FİYAT
3307	2 + 5 7 DELİKLİ DAĞITIM ÜNİTESİ	105	151	95	8	<b>618,8 ₺</b>
3310	2 + 8 10 DELİKLİ DAĞITIM ÜNİTESİ	145	151	95	4	<b>878,0 ₺</b>
3312	2 + 10 12 DELİKLİ DAĞITIM ÜNİTESİ	165	151	95	4	<b>1050,0 ₺</b>
3315	2 + 13 15 DELİKLİ DAĞITIM ÜNİTESİ	200	151	95	4	<b>1318,0 ₺</b>
3320	2 + 18 20 DELİKLİ DAĞITIM ÜNİTESİ	255	151	95	4	<b>1747,0 ₺</b>
3322	2 + 20 22 DELİKLİ DAĞITIM ÜNİTESİ	275	151	95	4	<b>1909,0 ₺</b>

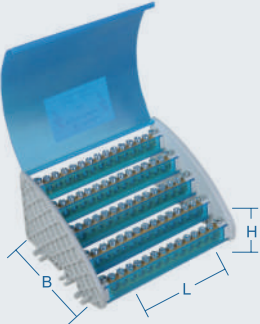

## Topraklama Klemensler

### Pano Topraklama Klemensleri (6x8 mm Kesit 63 Amp.)

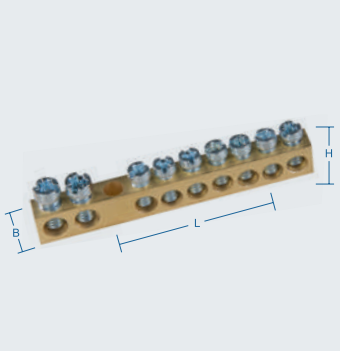

#### Teknik Özellikler

ÜRÜN KODU	AÇIKLAMA	L	B	H	KOLİ ADEDİ	FİYAT
1004	4 Delikli Topraklama Klemensi	33	6	8	1500	<b>12,60 ₺</b>
1005	5 Delikli Topraklama Klemensi	38	6	8	1500	<b>13,36 ₺</b>
1006	6 Delikli Topraklama Klemensi	45	6	8	1250	<b>17,85 ₺</b>
1007	7 Delikli Topraklama Klemensi	50	6	8	1000	<b>18,80 ₺</b>
1009	9 Delikli Topraklama Klemensi	62	6	8	1000	<b>21,00 ₺</b>
1010	10 Delikli Topraklama Klemensi	68	6	8	750	<b>23,90 ₺</b>
1012	12 Delikli Topraklama Klemensi	80	6	8	750	<b>30,50 ₺</b>

### Pano Topraklama Klemensleri Ayaklı (6,5x9 mm Kesit 80 Amp.)

#### Teknik Özellikler



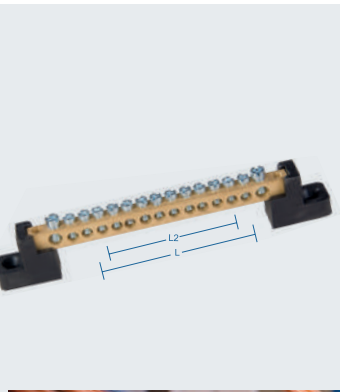

ÜRÜN KODU	AÇIKLAMA	L	L2	H	KOLİ ADEDİ	FİYAT
1106	6 Delikli Topraklama Klemensi	85	70	22	200	<b>29,80 ₺</b>
1107	7 Delikli Topraklama Klemensi	90	75	22	200	<b>32,75 ₺</b>
1110	10 Delikli Topraklama Klemensi	108	95	22	150	<b>40,00 ₺</b>
1112	12 Delikli Topraklama Klemensi	120	106	22	150	<b>42,90 ₺</b>
1115	15 Delikli Topraklama Klemensi	138	124	22	125	<b>52,60 ₺</b>
1120	20 Delikli Topraklama Klemensi	165	152	22	100	<b>68,80 ₺</b>
1125	25 Delikli Topraklama Klemensi	195	180	22	75	<b>87,00 ₺</b>
1130	30 Delikli Topraklama Klemensi	235	220	22	75	<b>124,00 ₺</b>



## Buat Klemensler

### Geçmeli Buat Klemensler

#### Teknik Özellikler

ÜRÜN KODU	KABLO KESİTİ	EN	BOY	YÜKSEKLİK	KOLİ ADEDİ	FİYAT
 ELX2.5-2	0.5-2.5 mm <sup>2</sup>	9,9	16,4	6	200	<b>0,114 \$</b>
 ELX2.5-3	0.5-2.5 mm <sup>2</sup>	13,9	16,4	6	200	<b>0,124 \$</b>
 ELX2.5-4	0.5-2.5 mm <sup>2</sup>	17,9	16,4	6	100	<b>0,146 \$</b>
 ELX2.5-5	0.5-2.5 mm <sup>2</sup>	21,9	16,4	6	100	<b>0,170 \$</b>
 ELX2.5-6	0.5-2.5 mm <sup>2</sup>	13,9	16,4	11,5	100	<b>0,198 \$</b>
 ELX2.5-8	0.5-2.5 mm <sup>2</sup>	17,9	16,4	11,5	50	<b>0,246 \$</b>

### Çok Amaçlı Klemensler

#### Teknik Özellikler

ÜRÜN KODU	KABLO KESİTİ	AÇIKLAMA	KOLİ ADEDİ	FİYAT
 ELX-412	0.14-4 mm <sup>2</sup>	2 İletken Bağlantılı	100	<b>0,219 \$</b>
 ELX-413	0.14-4 mm <sup>2</sup>	3 İletken Bağlantılı	100	<b>0,284 \$</b>
 ELX-414	0.14-4 mm <sup>2</sup>	4 İletken Bağlantılı	100	<b>0,350 \$</b>
 ELX-415	0.14-4 mm <sup>2</sup>	5 İletken Bağlantılı	50	<b>0,410 \$</b>

Çalışma Sıcaklığı: -40°C +105°C Nominal Akım: 32A Nominal Gerilim: 450V

## Plastik Kablo Bağları



ÜRÜN KODU	BOYUTLAR		RENK	P. MİKTARI	AÇIKLAMA	FİYAT
	En (mm)	Uzunluk (mm)				
ELX KB 2,5 x 100	2,5	100	Siyah - Beyaz	100	Plastik Kablo Bağları	<b>0.156 ₺</b>
ELX KB 2,5 x 150	2,5	150	Siyah - Beyaz	100	Plastik Kablo Bağları	<b>0.234 ₺</b>
ELX KB 2,5 x 200	2,5	200	Siyah - Beyaz	100	Plastik Kablo Bağları	<b>0.328 ₺</b>
ELX KB 3,6 x 150	3,6	150	Siyah - Beyaz	100	Plastik Kablo Bağları	<b>0.382 ₺</b>
ELX KB 3,6 x 200	3,6	200	Siyah - Beyaz	100	Plastik Kablo Bağları	<b>0.500 ₺</b>
ELX KB 3,6 x 250	3,6	250	Siyah - Beyaz	100	Plastik Kablo Bağları	<b>0.601 ₺</b>
ELX KB 3,6 x 300	3,6	300	Siyah - Beyaz	100	Plastik Kablo Bağları	<b>0.765 ₺</b>
ELX KB 3,6 x 370	3,6	370	Siyah - Beyaz	100	Plastik Kablo Bağları	<b>0.960 ₺</b>
ELX KB 4,8 x 200	4,8	200	Siyah - Beyaz	100	Plastik Kablo Bağları	<b>0.703 ₺</b>
ELX KB 4,8 x 250	4,8	250	Siyah - Beyaz	100	Plastik Kablo Bağları	<b>0.828 ₺</b>
ELX KB 4,8 x 300	4,8	300	Siyah - Beyaz	100	Plastik Kablo Bağları	<b>1.046 ₺</b>
ELX KB 4,8 x 380	4,8	380	Siyah - Beyaz	100	Plastik Kablo Bağları	<b>1.305 ₺</b>
ELX KB 4,8 x 450	4,8	450	Siyah - Beyaz	100	Plastik Kablo Bağları	<b>1.593 ₺</b>
ELX KB 4,8 x 500	4,8	500	Siyah - Beyaz	100	Plastik Kablo Bağları	<b>1.796 ₺</b>
ELX KB 8 x 300	8	300	Siyah - Beyaz	100	Plastik Kablo Bağları	<b>2.031 ₺</b>
ELX KB 8 x 380	8	380	Siyah - Beyaz	100	Plastik Kablo Bağları	<b>2.340 ₺</b>
ELX KB 8 x 450	8	450	Siyah - Beyaz	100	Plastik Kablo Bağları	<b>2.810 ₺</b>
ELX KB 8 x 550	8	550	Siyah - Beyaz	100	Plastik Kablo Bağları	<b>3.830 ₺</b>
ELX KB 8 x 650	8	650	Siyah - Beyaz	100	Plastik Kablo Bağları	<b>5.150 ₺</b>
ELX KB 8x 750	8	750	Siyah - Beyaz	100	Plastik Kablo Bağları	<b>5.620 ₺</b>
ELX KB 9 x 900	8	900	Siyah - Beyaz	100	Plastik Kablo Bağları	<b>9,95 ₺</b>
ELX KB 9 x 950	8	950	Siyah - Beyaz	100	Plastik Kablo Bağları	<b>10,46 ₺</b>
ELX KB 9 x 1000	8	1000	Siyah - Beyaz	100	Plastik Kablo Bağları	<b>10,86 ₺</b>
ELX KB 9 x 1200	8	1200	Siyah - Beyaz	100	Plastik Kablo Bağları	<b>12,80 ₺</b>

## Yapışkanlı Kroşeler

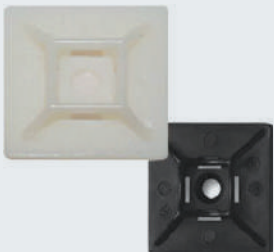

### Teknik Özellikler

ÜRÜN KODU	RENK	ÖLÇÜ	K. ADEDİ	AÇIKLAMA	FİYAT
ELX YK20	Beyaz	20 x 20	100	Yapışkanlı Kroşe	<b>1,100 ₺</b>
ELX YK25	Beyaz	25 x 25	100	Yapışkanlı Kroşe	<b>1,500 ₺</b>
ELX YK30	Beyaz	30 x 30	100	Yapışkanlı Kroşe	<b>1,980 ₺</b>
ELX YK40	Beyaz	40 X 40	50	Yapışkanlı Kroşe	<b>3,950 ₺</b>



# tbloc

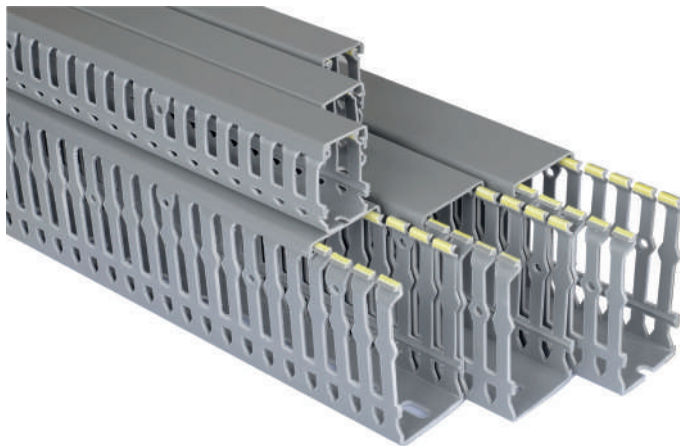
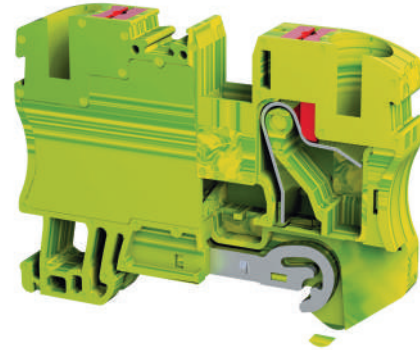
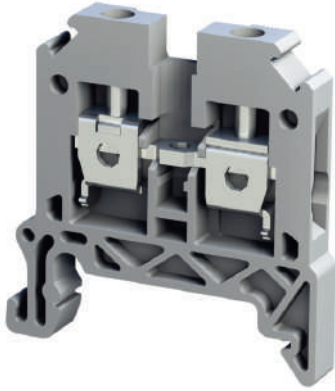
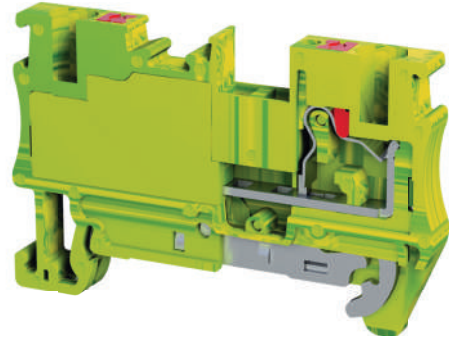
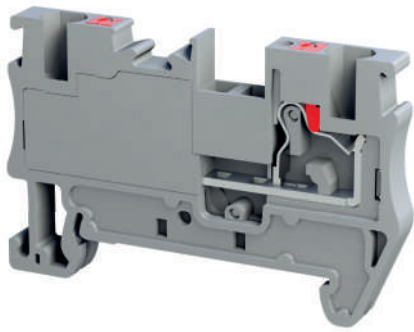

## Vinç Kumanda Butonları

### COB61

Mekanik Kilitli  
Tek Hızlı

**FİYAT: 4,0 \$**



<b>ÜRÜN KODU</b>	COB61-VK2
<b>AÇIKLAMA</b>	Tek Hızlı 2'li Vinç Kumanda Mekanik Kilitli Kontakt 5A
<b>KUTU ADEDİ</b>	1 Adet

### COB62

Mekanik Kilitli  
Tek Hızlı

**FİYAT: 5,25 \$**



<b>ÜRÜN KODU</b>	COB62-VK4
<b>AÇIKLAMA</b>	Tek Hızlı 4'lü Vinç Kumanda Mekanik Kilitli Kontakt 5A
<b>KUTU ADEDİ</b>	1 Adet

### COB63

Mekanik Kilitli  
Tek Hızlı

**FİYAT: 6,875 \$**



<b>ÜRÜN KODU</b>	COB63-VK6
<b>AÇIKLAMA</b>	Tek Hızlı 6'lı Vinç Kumanda Mekanik Kilitli Kontakt 5A
<b>KUTU ADEDİ</b>	1 Adet

### COB64

Mekanik Kilitli  
Tek Hızlı

**FİYAT: 9.375 \$**



<b>ÜRÜN KODU</b>	COB64-VK8
<b>AÇIKLAMA</b>	Tek Hızlı 8'li Vinç Kumanda Mekanik Kilitli Kontakt 5A
<b>KUTU ADEDİ</b>	1 Adet

### COBC1

Mekanik Kilitli - Tek  
Hızlı - Faz Bağlantı  
Köprülü

**FİYAT: 16,25 \$**



<b>ÜRÜN KODU</b>	COBC1-VKB3
<b>AÇIKLAMA</b>	Tek Hızlı 2 + Acil Stop Vinç Ku- manda Mekanik Kilitli Kontakt 16A
<b>KUTU ADEDİ</b>	1 Adet

### COBC2

Mekanik Kilitli - Tek  
Hızlı - Faz Bağlantı  
Köprülü

**FİYAT: 22,50 \$**



<b>ÜRÜN KODU</b>	COBC2-VKB5
<b>AÇIKLAMA</b>	Tek Hızlı 4 + Acil Stop Vinç Ku- manda Mekanik Kilitli Kontakt 16A
<b>KUTU ADEDİ</b>	1 Adet

### COBC3

Mekanik Kilitli - Tek  
Hızlı - Faz Bağlantı  
Köprülü

**FİYAT: 29,37 \$**



<b>ÜRÜN KODU</b>	COBC3-VKB7
<b>AÇIKLAMA</b>	Tek Hızlı 6 + Acil Stop Vinç Ku- manda Mekanik Kilitli Kontakt 16A
<b>KUTU ADEDİ</b>	1 Adet

### COBC4

Mekanik Kilitli - Tek  
Hızlı - Faz Bağlantı  
Köprülü

**FİYAT: 35,00 \$**



<b>ÜRÜN KODU</b>	COBC4-VKB8
<b>AÇIKLAMA</b>	Tek Hızlı 8 + Acil Stop Vinç Ku- manda Mekanik Kilitli Kontakt 16A
<b>KUTU ADEDİ</b>	1 Adet

## Vinç Kumanda Butonları / Ayak Pedalları

### KB 2

Araç Lift Kumanda  
Çift Kontaklı

**FİYAT: 11,90 \$**



ÜRÜN KODU	KB-2
AÇIKLAMA	Lift Kumanda 2'li Tek Hızlı Çift Kontaklı 10A
KUTU ADEDİ	1 Adet

### AP-9

Ayak Pedalları  
Kablosuz

**FİYAT: 33,6 \$**



ÜRÜN KODU	ELX-FSMS/1
KONTAK TİPİ	1NO+1NC
AÇIKLAMA	Döküm Korumalı Kapaklı Pedal Kablosuz
KUTU ADEDİ	1 Adet

### AP-9

Ayak Pedalları  
2 mt Kablolu

**FİYAT: 37,0 \$**



ÜRÜN KODU	ELX-FSMS/1
KONTAK TİPİ	1NO+1NC
AÇIKLAMA	Döküm Korumalı Kapaklı Pedal 2 m Kablolu
KUTU ADEDİ	1 Adet

### FS-1 METAL

Ayak Pedalları

**FİYAT: 6,85 \$**



ÜRÜN KODU	FS-1-AP1
KONTAK TİPİ	1NO+1NC
AÇIKLAMA	2 METRE Kablolü Metal Pedal
KUTU ADEDİ	1 Adet

### FS-2 METAL

Ayak Pedalları

**FİYAT: 8,28 \$**



ÜRÜN KODU	FS-2-AP2
KONTAK TİPİ	1NO+1NC
AÇIKLAMA	Kablolu 1 mt Döküm Pedal
KUTU ADEDİ	1 Adet

### FS-3 METAL

Ayak Pedalları

**FİYAT: 11,44 \$**



ÜRÜN KODU	FS-3-AP3
KONTAK TİPİ	1NO+1NC
AÇIKLAMA	Kablolu 1 mt Döküm Pedal
KUTU ADEDİ	1 Adet

## KOMPAKT AKSİYEL METAL FAN TAIDA - İKLİMLENDİRME ÜRÜNLERİ

ÜRÜN KODU	ÖLÇÜ	YATAKLAMA	VOLTAJ 50/60HZ	AKIM(A)	GÜÇ(W)	HIZ(RPM)	HAVA AKIMI (CFM)	GÜRÜLTÜ SEVİYESİ (dBA)	BİRİM FİYAT \$
ELX-PFT-80-12	80X80X25	BİLEZİKLİ	12 V DC	0,14	1,68	2600	32,9	29,2	<b>3,47</b> \$
ELX-PFT-80-24	80X80X25	BİLEZİKLİ	24 V DC	0,08	1,92	3000	38,6	32	<b>3,47</b> \$
ELX-PFT-80-220	80X80X25	BİLEZİKLİ	220 V AC	0,09/0,08	14,13	2350/2500	15/18	27/28	<b>9,55</b> \$
ELX-PFT-80-220-38	80X80X38	BİLEZİKLİ	220 V AC	0,08/0,07	25/13	2300/2600	23/30	25/26	<b>9,55</b> \$
ELX-PFT-92-12	92X92X25	BİLEZİKLİ	12 V DC	0,16	1,92	2400	43,5	31,1	<b>3,47</b> \$
ELX-PFT-92-24	92X92X25	BİLEZİKLİ	24 V DC	0,12	2,88	2500	45	31,5	<b>3,47</b> \$
ELX-PFT-92-110	92X92X25	BİLEZİKLİ	110 V AC	0,11/0,1	16/15	2300/2500	28/34	27/28	<b>9,55</b> \$
ELX-PFT-92-220	92X92X25	BİLEZİKLİ	220 V AC	0,08/0,07	16/15	2300/2500	28/34	27/26	<b>9,55</b> \$
ELX-PFT-92-220-38	92X92X38	BİLEZİKLİ	220 V AC	0,08/0,07	18/17	2400/2500	50/54	29/28	<b>9,55</b> \$
ELX-PFT-120-12	120X120X25	BİLEZİKLİ	12 V DC	0,28	3,36	2000	74,2	35,5	<b>9,55</b> \$
ELX-PFT-120-14	120X120X25	BİLEZİKLİ	24 V DC	0,25	4,08	2000	74,2	35,5	<b>9,55</b> \$
ELX-PFT-120-110	120X120X25	BİLEZİKLİ	110 V AC	0,20/0,19	16/15	2500/2700	38/42	37/37,50	<b>9,55</b> \$
ELX-PFT-120-22	120X120X25	BİLEZİKLİ	220 V AC	0,11/0,1	19/18	2500/2700	38/42	40,41	<b>9,55</b> \$
ELX-PFT-120-12-38	120X120X38	BİLEZİKLİ	12 V DC	0,34	4,08	2500	90	36,5	<b>9,55</b> \$
ELX-PFT-120-24-38	120X120X38	BİLEZİKLİ	24 V DC	0,2	4,8	2300	85	35	<b>9,55</b> \$
ELX-PFT-120-110-38	120X120X38	BİLEZİKLİ	110 V AC	0,24/0,23	22/21	2600/3000	90/100	42/44	<b>9,55</b> \$
ELX-PFT-120-220-38	120X120X38	BİLEZİKLİ	220 V AC	0,14/0,13	22/21	2900/3000	90/100	42/44	<b>9,55</b> \$
ELX-PFT-172-12	172X151X51	BİLEZİKLİ	12 V DC	1,2	14,4	2300	1585	47	<b>27,8</b> \$
ELX-PFT-172-24	172X151X51	BİLEZİKLİ	24 V DC	0,63	15,6	2400	160	47,2	<b>27,8</b> \$
ELX-PFT-172-110	172X151X51	RULMANLI	110 V AC	0,47/0,46	37/35	2400/2800	150/70	47/47,50	<b>27,8</b> \$
ELX-PFT-172-220	172X151X51	RULMANLI	220 V AC	0,23/0,22	35/33	2400/2800	150/70	45/46	<b>27,8</b> \$
ELX-PFT-200-220	200X200X60	RULMANLI	220 V AC	0,31/03,30	56/54	2000/2050	180/178	41/42	<b>33,30</b> \$
ELX-PFT-225-220	225X225X80	RULMANLI	220 V AC	0,4	80	2600		65	<b>104</b> \$
ELX-PFT-280-220	280X280X80	RULMANLI	220 V AC	0,55	120	2400/2650		65/75	<b>138</b> \$



## KOMPAKT AKSİYEL METAL FAN SALZER - İKLİMLENDİRME ÜRÜNLERİ

ÜRÜN KODU	ÖLÇÜ	YATAKLAMA	VOLTAJ 50/60HZ	AKIM(A)	GÜÇ(W)	HIZ(RPM)	HAVA AKIMI (CFM)	GÜRÜLTÜ SEVİYESİ (dBA)	BİRİM FİYAT \$
ELX-PFS-80-12	80X80X25	BİLEZİKLİ	12 V DC	0,28	3,36	3000	30,73	33,5	<b>5,20</b> \$
ELX-PFS-80-24	80X80X25	BİLEZİKLİ	24 V DC	0,18	3,36	3000	30,73	33,5	<b>5,20</b> \$
ELX-PFS-80-220	80X80X25	BİLEZİKLİ	220 V AC	0,07	11,16	2300	21/0,59	22	<b>13,90</b> \$
ELX-PFS-80-220-38	80X80X38	BİLEZİKLİ	220 V AC	0,09	3,36	2500	24/0,68	25,5	<b>13,90</b> \$
ELX-PFS-92-12	92X92X25	BİLEZİKLİ	12 V DC	0,2	3,48	2500	54,44	32,6	<b>5,20</b> \$
ELX-PFS-92-24	92X92X25	BİLEZİKLİ	24 V DC	0,2	12	2500	64,16	34,3	<b>5,20</b> \$
ELX-PFS-92-220	92X92X25	BİLEZİKLİ	110 V AC	0,09	12	2500	54,44	32,6	<b>13,90</b> \$
ELX-PFS-92-220-38	92X92X38	BİLEZİKLİ	220 V AC	0,09	12	2500	54,44	32,6	<b>13,90</b> \$
ELX-PFS-120-12	120X120X25	BİLEZİKLİ	12 V DC	0,37	2,28	1800	65,63	32,5	<b>13,90</b> \$
ELX-PFS-120-14	120X120X25	BİLEZİKLİ	24 V DC	0,25	4,08	2000	74,2	35,5	<b>13,90</b> \$
ELX-PFS-120-110	120X120X25	BİLEZİKLİ	110 V AC	0,14	18	2500	87/2,46	46,5	<b>13,90</b> \$
ELX-PFS-120-22	120X120X25	BİLEZİKLİ	220 V AC	0,1	17	2100	61/1,72	36	<b>13,90</b> \$
ELX-PFS-120-12-38	120X120X38	BİLEZİKLİ	12 V DC	0,8	9,6	3000	118,7	43,8	<b>13,90</b> \$
ELX-PFS-120-24-38	120X120X38	BİLEZİKLİ	24 V DC	0,4	9,6	3000	118,7	43,8	<b>13,90</b> \$
ELX-PFS-120-110-38	120X120X38	BİLEZİKLİ	110 V AC	0,14	18	2500	87/2,46	46,5	<b>13,90</b> \$
ELX-PFS-120-220-38	120X120X38	BİLEZİKLİ	220 V AC	0,08	19	2500	87/2,46	46,5	<b>13,90</b> \$
ELX-PFS-172-12	172X151X51	BİLEZİKLİ	12 V DC	1	12	2800	158,8	62	<b>62,5</b> \$
ELX-PFS-172-24	172X151X51	BİLEZİKLİ	24 V DC	0,45	11	2800	158,8	62	<b>62,5</b> \$
ELX-PFS-172-110	172X151X51	RULMANLI	110 V AC	0,38	24	2500/2700	180/5,10	49,6	<b>41,70</b> \$
ELX-PFS-172-220	172X151X51	RULMANLI	220 V AC	0,18	28	2500	180/5,10	49,6	<b>41,70</b> \$
ELX-PFS-200-220	200X200X60	RULMANLI	220 V AC	0,45	70	2500	285/8,07	60	<b>76,40</b> \$
ELX-PFS-225-220	225X225X80	RULMANLI	220 V AC	0,29	62	2450	540/915	59	<b>138,90</b> \$
ELX-PFS-280-220	280X280X80	RULMANLI	220 V AC	0,56	127	2520	1060/1800	68	<b>173,60</b> \$



## DEMEX MARKA FANLAR - İKLİMLENDİRME ÜRÜNLERİ

ÜRÜN KODU	ÖLÇÜ	YATAKLAMA	VOLTAJ 50/60HZ	AKIM(A)	GÜÇ(W)	HIZ(RPM)	HAVA AKIMI (CFM)	GÜRÜLTÜ SEVİYESİ (dBA)	BİRİM FİYAT
DMX-PF-120-220-B	120X120X38	BİLEZİKLİ	220 V AC	0,12/0,14	21/18	2600/3000	160/166	43/48	11,50 \$
DMX-PF-120-220-R	120X120X38	RULMANLI	220 V AC	0,12/0,14	21/18	2600/3000	160/166	43/48	13,90 \$
DMX-PF-225-220-R	225X225X80	RULMANLI	220 V AC	0,25/0,33	54/71	2650/3100	597/661	59/61	121,5 \$
DMX-PF-120-24	120X120X38		24 V DC	0,34	8,16	3100	1	46	11,5 \$
DMX-PF-172-220-R	172X150X55	RULMANLI	220 V AC	0,22	35	2800	200/240	50/54	69,5 \$
DMX-PF-225-220-R	225X225X80	RULMANLI	220 V AC	0,25/0,33	54/71	2650/3100	597/661	59/61	121,5 \$
DMX-PF-280-220-R	280X280X80	RULMANLI	220 V AC	0,55	120	2400/2650		65/75	156 \$



## Turbo Fanlar

L	L1	L2	L3	A	VOLTAJ 50 HZ	AKIM(A)	GÜÇ(W)	HIZ(RPM)	GÜRÜLTÜ SEVİYESİ (dBA)	BİRİM FİYAT
180	183	195	56	16	220	0,26	21,6	1750	51	27,8 \$
240	243	255	60	20	220	0,27	40,6	2150	52	34,8 \$
300	303	315	60	20	220	0,3	15,1	1030	49	41,70 \$

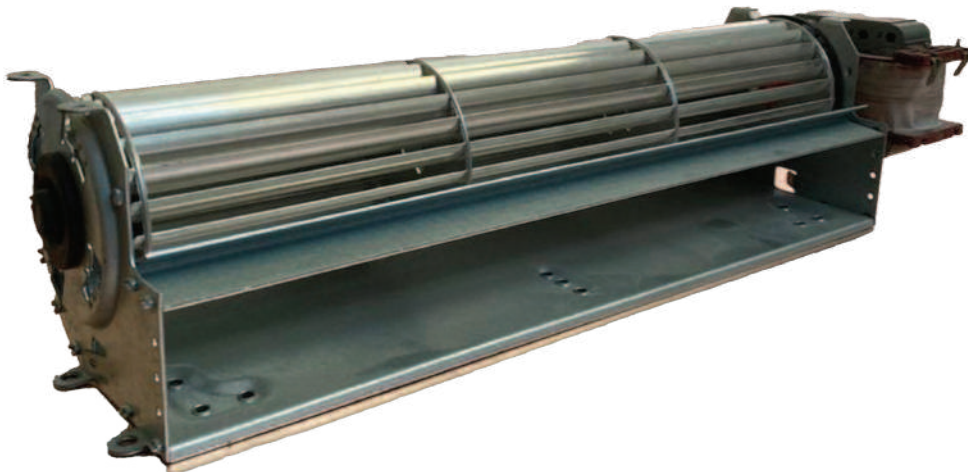

Gövdesi yüksek ısı uygulamaları için özel olarak ısıya dayanıklı yüksek kalite galvanize çelik saçdan, fanı alüminyumdan üretilmiştir. • Dikey Buzdolapları. • Hava Perdeleri. • Fırınlar. • Doğalgaz sobaları. • El kurutma cihazları. • Zemin seviye ısıtıcıları. • Isıtma-Soğutma amaçlı bütün endüstriyel uygulamalarda kullanılır.

## FAN FİLTRESİ - FAN TELİ - DEMEX TERMOSTATLAR-İKLİMLENDİRME ÜRÜNLERİ

DAVLUMBAZ	25 X 25	80	₺
ELX-FF-92	92X92	38	₺
ELX-FF-120	120X120	45	₺
ELX-FF-250	250X250	210	₺
ELX-FT-80	80X80	0,65	\$
ELX-FT-92	92X92	0,65	\$
ELX-FT-120	120X120	0,90	\$
ELX-FT-172	172X172	1,80	\$
ELX-FT-200	200X200	5,41	\$
ELX-FT-280	280X280	7,2	\$
DMX-1140	ISITICI TERMOSTAT	6,9	\$
DMX-1141	FAN KONTROL	6,9	\$
DMX-FZK011	TERMOSTAT	16,6	\$
DMX-ZR011	SOĞUTMA VE ISITICI TERMOSTAT	17,36	\$
DMX-MFR-012	HİGROSTAT	69,45	\$
DMX-7000	ODA TERMOSTATI	17,36	\$



## DEMEX / DMX-300 ÇATI FANI DATASHEET

### Technical Specificaion / Teknik Özellikler

Rated Voltage :	220 VAC
Frequency :	50 Hz.
Diemensions :	382x390x144,5 mm
Current :	0,25 A
Motor Power :	35 W
Speed (r/m) :	2800 devir/dakika
Flow Rate :	300 m <sup>3</sup> /s
Temperature :	-10° +70°
Noise Level :	51 Db
<b>FIYAT :</b>	<b>104,20 \$</b>

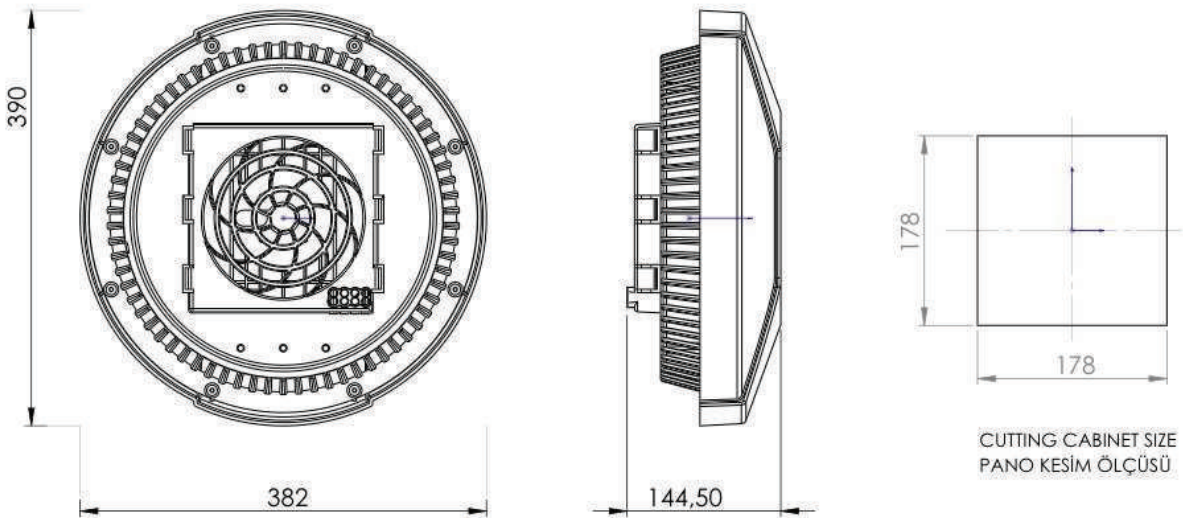



## DEMEX / DMX-600 ÇATI FANI DATASHEET

### Technical Specificaion / Teknik Özellikler

Rated Voltage :	220 VAC
Frequency :	50 Hz.
Diemensions :	382x390x144,5 mm
Current :	0,3 A
Motor Power :	65 W
Speed (r/m) :	2400 devir/dakika
Flow Rate :	634 m <sup>3</sup> /s
Temperature :	-10° +70°
Noise Level :	60 dB
<b>FİYAT :</b>	<b>138,9 \$</b>

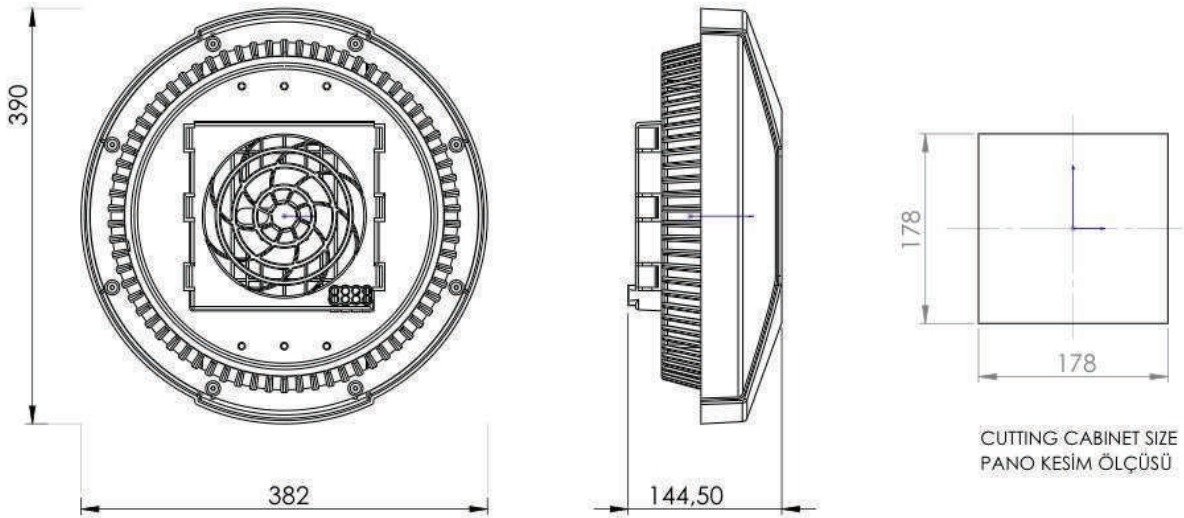

## DEMEX / DMX-900 ÇATI FANI DATASHEET

### Technical Specifcaion / Teknik Özellikler

Rated Voltage :	220 VAC
Frequency :	50 Hz.
Diemensions :	382x390x144,5 mm
Current :	0,40 A
Motor Power :	90 W
Speed (r/m) :	2600 devir/dakika
Flow Rate :	900 m <sup>3</sup> /s
Temperature :	-10° +70°
Noise Level :	60 dB

**FİYAT : 156,2 \$**

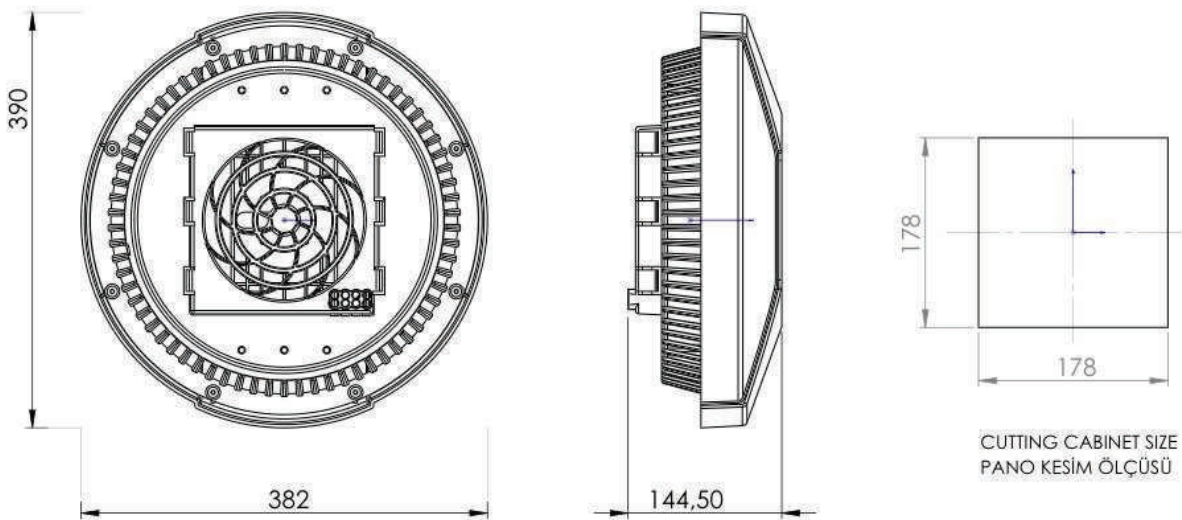

## DEMEX / DMX-1250 ÇATI FANI DATASHEET

### Technical Specificaion / Teknik Özellikler

Rated Voltage :	220 VAC
Frequency :	50 Hz.
Diemensions :	382x390x144,5 mm
Current :	0,42 A
Motor Power :	90 W
Speed (r/m) :	2500 devir/dakika
Flow Rate :	1200 m <sup>3</sup> /s
Temperature :	-10° +70°
Noise Level :	60 dB
<b>FİYAT :</b>	<b>173,6 \$</b>

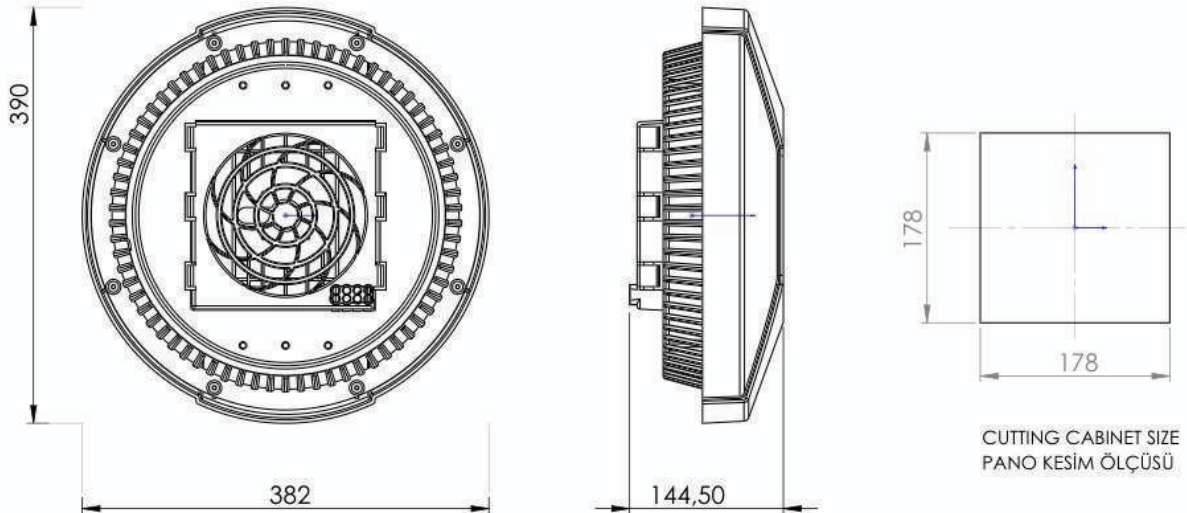

**BELGELERİMİZ**

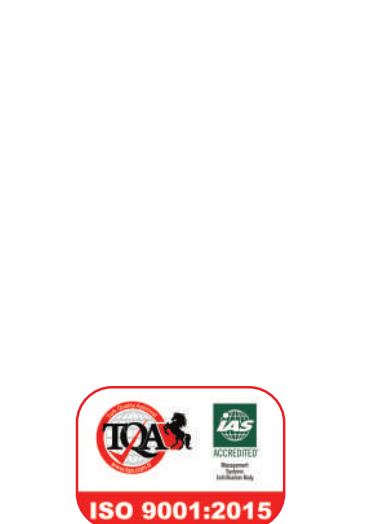

# BELGELERİMİZ

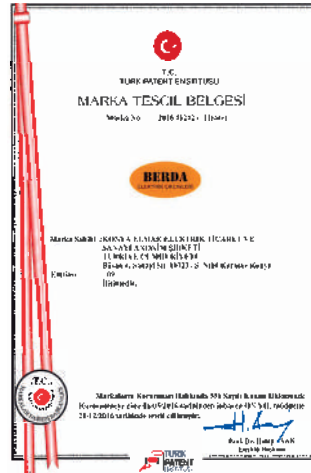
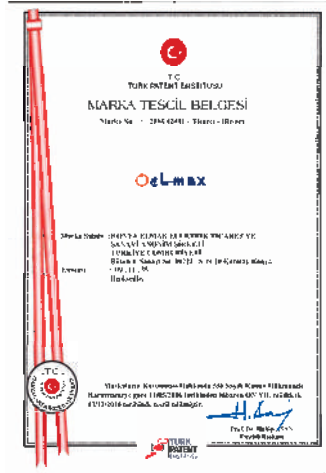

\* Bu fiyat listesi Şubat 2023 tarihinden itibaren geçerlidir.  
\* Fiyatlarımızda herhangi bir gerekçe göstermeksizin değişiklik yapma hakkımız mahfuzdur.  
\* Faturalamada teslim tarihindeki liste fiyatları geçerlidir.

\* Tipografik hatalardan firmamız sorumlu değildir.  
\* Siparişlerinizde stok sorunuz.  
\* Fiyatlarımıza KDV dahil değildir.

**NOT**

A series of horizontal dashed lines for writing notes.









**NOT**

Area with horizontal dashed lines for notes.



 *since 1943*

**Konya Elmak Elektrik Tic. ve San. A.Ş.**

Büsan Organize Sanayi Sitesi 10723 Sokak

No:10 P.K. 42050 Karatay/KONYA

Tel : 0 332 345 18 11

Fax : 0 332 345 18 14

**İstanbul Bölge** : 0 530 406 44 59

**İç Anadolu Bölge** : 0 530 406 44 58

**Akdeniz Bölge** : 0 530 602 59 50

**Ege Bölge** : 0 530 291 08 42

**G. Doğu Bölge** : 0 530 140 16 14

**Ankara Home Office** : 0 530 291 08 42

**Konya Bölge** : 0 530 602 59 50

0 530 602 63 74

0 533 155 91 40

**[www.el-max.com.tr](http://www.el-max.com.tr)**



**[www.ozbekenerji.com.tr](http://www.ozbekenerji.com.tr)**